



KV8 Pro

*AMD Athlon™ 64 System Board
Socket 754*

User's Manual

Copyright and Warranty Notice

The information in this document is subject to change without notice and does not represent a commitment on part of the vendor, who assumes no liability or responsibility for any errors that may appear in this manual.

No warranty or representation, either expressed or implied, is made with respect to the quality, accuracy or fitness for any particular part of this document. In no event shall the manufacturer be liable for direct, indirect, special, incidental or consequential damages arising from any defect or error in this manual or product.

Product names appearing in this manual are for identification purpose only and trademarks and product names or brand names appearing in this document are the property of their respective owners.

This document contains materials protected under International Copyright Laws. All rights reserved. No part of this manual may be reproduced, transmitted or transcribed without the expressed written permission of the manufacturer and authors of this manual.

If you do not properly set the motherboard settings, causing the motherboard to malfunction or fail, we cannot guarantee any responsibility.

Table Of Contents

Chapter 1. Introduction	1-1
1-1. Features & Specifications	1-1
1-2. Layout Diagram	1-3
Chapter 2. Hardware Setup.....	2-1
2-1. Install The Motherboard.....	2-1
2-2. Install CPU and Heatsink	2-2
2-3. Install System Memory	2-3
2-4. Connectors, Headers and Switches	2-5
(1). ATX Power Input Connectors.....	2-5
(2). FAN Connectors.....	2-6
(3). CMOS Memory Clearing Header	2-7
(4). Wake-up Header.....	2-8
(5). Front Panel Switches & Indicators Headers	2-9
(6). Additional USB Port Headers.....	2-10
(7). Front Panel Audio Connection Header	2-11
(8). Internal Audio Connectors	2-12
(9). Accelerated Graphics Port Slot.....	2-13
(10). Floppy Disk Drive Connector.....	2-14
(11). IDE Connectors.....	2-15
(12). POST Code Display	2-16
(13). Serial ATA Connectors.....	2-17
(14). Status Indicators.....	2-18
(15). System Management Bus Headers.....	2-19
(16). Back Panel Connectors	2-20
Chapter 3. BIOS Setup.....	3-1
3-1. µGuru Utility.....	3-3
3-2. Standard CMOS Features.....	3-9
3-3. Advanced BIOS Features.....	3-12
3-4. Advanced Chipset Features.....	3-14
3-5. Integrated Peripherals	3-18
3-6. Power Management Setup	3-21
3-7. PnP/PCI Configurations	3-24
3-8. Load Fail-Safe Defaults	3-26
3-9. Load Optimized Defaults	3-26

3-10.	Set Password	3-26
3-11.	Save & Exit Setup	3-26
3-12.	Exit Without Saving.....	3-26
<i>Appendix A.</i>	<i>Install VIA 4-in-1 Driver</i>	<i>A-1</i>
<i>Appendix B.</i>	<i>Install Audio Driver</i>	<i>B-1</i>
<i>Appendix C.</i>	<i>Install LAN Driver</i>	<i>C-1</i>
<i>Appendix D.</i>	<i>Install VIA USB 2.0 Driver</i>	<i>D-1</i>
<i>Appendix E.</i>	<i>Install VIA Serial ATA RAID Driver.....</i>	<i>E-1</i>
<i>Appendix F.</i>	<i>Install ABIT μGuru Driver.....</i>	<i>F-1</i>
<i>Appendix G.</i>	<i>POST Code Definition.....</i>	<i>G-1</i>
<i>Appendix H.</i>	<i>Troubleshooting (Need Assistance?).....</i>	<i>H-1</i>
<i>Appendix I.</i>	<i>How to Get Technical Support.....</i>	<i>I-1</i>

Chapter 1. Introduction

1-1. Features & Specifications

1. CPU

- Supports 64-bit AMD Athlon™ 64 processor (Socket 754)
- 1600MHz system bus using HyperTransport™ technology

2. CPU Integrated Memory Controller

- 72-bit memory controller supports DDR at 266, 333 and 400MHz
- Support 2 DIMM DDR 400
- Support 2 DIMM up to 2GB Max.

3. Chipset

- VIA K8T800 Pro + VT8237
- Up to 2000MHz HyperTransport
- Supports Advanced Configuration and Power Management Interface (ACPI)
- Accelerated Graphics Port connector supports AGP 8X/4X (0.8V/1.5V)

4. SATA RAID

- Supports SATA data transfer rates at 150 MB/s (1.5G bps)
- Supports SATA RAID 0/1 JBOD

5. Gigabit LAN

- On board VT6122 10/100/1000 Mb PCI Ethernet Controller

6. Audio

- On board 6-Channel AC 97 CODEC
- Professional digital audio interface supports optical S/PDIF Input/Output

7. ABIT Engineered

- ABIT μGuru™ Technology
- ABIT SoftMenu™ Technology
- ABIT FanEQ™ Technology
- CPU ThermalGuard™ Technology

8. Internal I/O Connectors

- 1x AGP 8X/4X slot
- 5x PCI slots
- 1x floppy port supports up to 2.88MB
- 2x Ultra DMA 33/66/100/133 connectors
- 2x Serial ATA 150 connectors

- 2x USB headers
- 1x CD-IN, 1x AUX-IN header

9. Back Panel I/O

- 1x PS/2 keyboard, 1x PS/2 mouse
- 1x Serial port connector, 1x Parallel port connector
- 1x S/PDIF In connector
- 1x S/PDIF Out connector
- 5 holes Audio connector (Front Speaker, Line-In, Mic-In, Center/Sub, Surround Speaker)
- 4x USB, 1x RJ-45 LAN Connector

10. Miscellaneous

- ATX form factor: 305 x 225 mm

* **Specifications and information contained herein are subject to change without notice.**

1-2. Layout Diagram

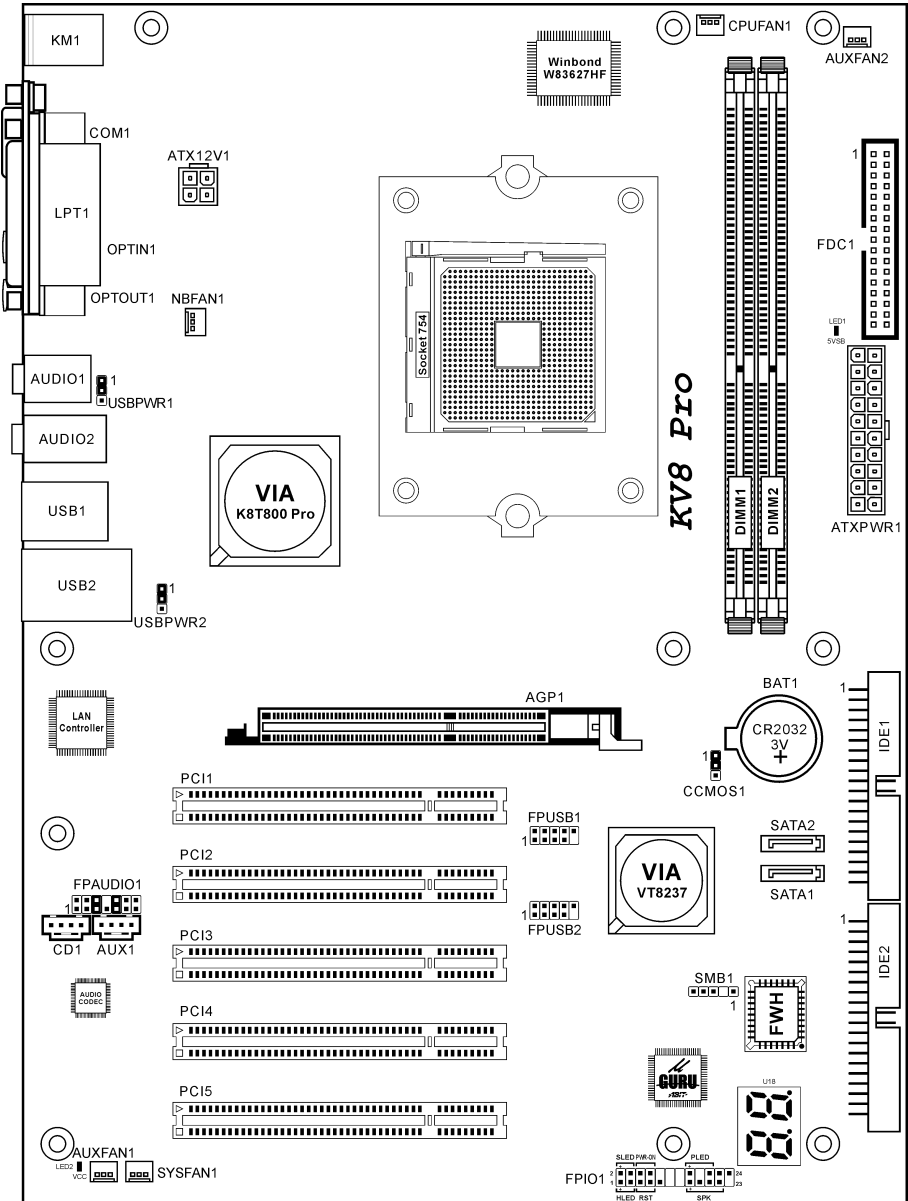



Chapter 2. Hardware Setup

Before the Installation: Turn off the power supply switch (fully turn off the +5V standby power), or disconnect the power cord before installing or unplugging any connectors or add-on cards. Failing to do so may cause the motherboard components or add-on cards to malfunction or damaged.

2-1. Install The Motherboard

Most computer chassis have a base with many mounting holes to allow motherboard to be securely attached on and at the same time, prevented from short circuits. There are two ways to attach the motherboard to the chassis base:

1. use with studs
2. or use with spacers

In principle, the best way to attach the board is to use with studs. Only if you are unable to do this should you attach the board with spacers. Line up the holes on the board with the mounting holes on the chassis. If the holes line up and there are screw holes, you can attach the board with studs. If the holes line up and there are only slots, you can only attach with spacers. Take the tip of the spacers and insert them into the slots. After doing this to all the slots, you can slide the board into position aligned with slots. After the board has been positioned, check to make sure everything is OK before putting the chassis back on.

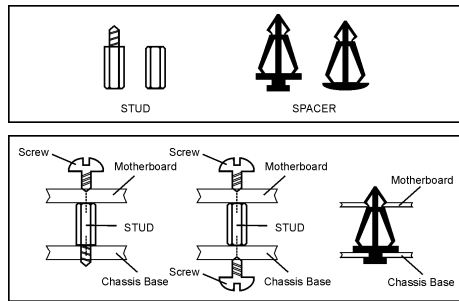

ATTENTION: To prevent shorting the PCB circuit, please REMOVE the metal studs or spacers if they are already fastened on the chassis base and are without mounting-holes on the motherboard to align with.

2-2. Install CPU and Heatsink

This motherboard provides a ZIF (Zero Insertion Force) Socket 754 to install AMD Socket 754 CPU. The CPU you bought should contain with a kit of heatsink, cooling fan, retention frame and blackplate. If that's not the case, buy one specially designed for Socket 754.

Please refer to the figure shown here to install CPU and heatsink. (For reference only. Your Heatsink & Fan Assembly may not be exactly the same as this one.)

1. Locate the Socket 754 on this motherboard. Pull the CPU release lever sideways to unlatch and then raise it all the way up.
2. Drop the processor with its pin side down into the CPU socket. Do not use extra force to insert CPU; it only fits in one direction. Close the CPU release lever.
3. Align the Backplate Standoffs with the mounting holes on motherboard. Position the backplate onto motherboard.
4. Place the Retention Frame onto the motherboard and align it with the Backplate Standoffs.
5. Place heatsink on top of CPU, and make sure the heatsink fits properly on the retention frame.
6. Hook both sides of the Spring Clip onto the Mounting Tabs of Retention Frame. Tighten screws until the Spring Clip is fully installed.
7. Attach the fan connector of Heatsink & Fan Assembly with the CPU-FAN connector on the motherboard.

ATTENTION: Do not forget to set the correct bus frequency and multiple for your processor.

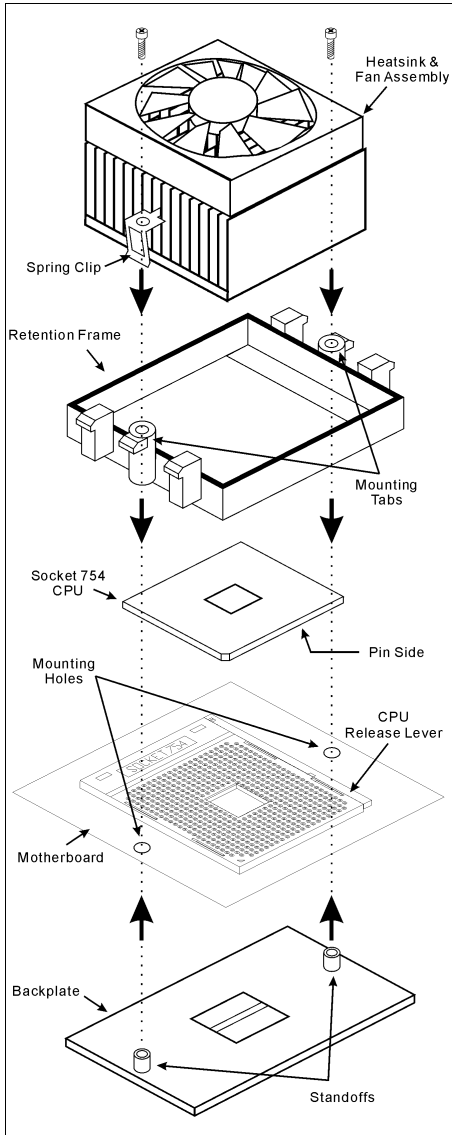

2-3. Install System Memory

This motherboard provides 2 184-pin DDR DIMM slots for memory expansion available from minimum 128MB to maximum 2GB.

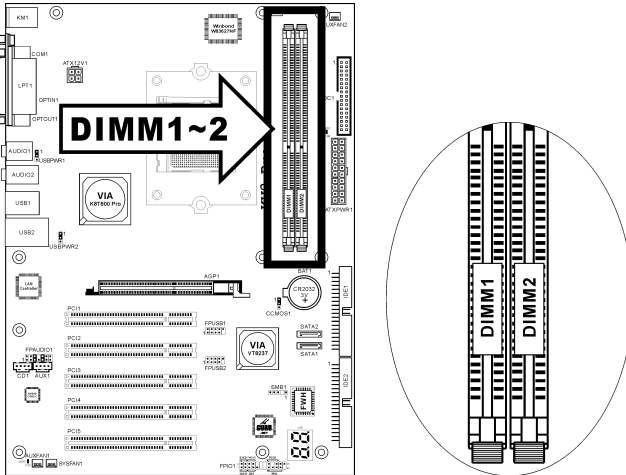

Table 2-1. Valid Memory Configurations

Bank	Memory Module	Total Memory
Bank 0, 1 (DIMM1)	128, 256, 512MB, 1GB	128MB ~ 1GB
Bank 2, 3 (DIMM2)	128, 256, 512MB, 1GB	128MB ~ 1GB
Total System Memory		128MB ~ 2GB

NOTE: No hardware or BIOS setup required after adding or removing memory modules.

Power off the computer and unplug the AC power cord before installing or removing memory modules.

1. Locate the DIMM slot on the board.
2. Hold two edges of the DIMM module carefully, keep away of touching its connectors.
3. Align the notch key on the module with the rib on the slot.
4. Firmly press the module into the slots until the ejector tabs at both sides of the slot automatically snaps into the mounting notch. Do not force the DIMM module in with extra force as the DIMM module only fit in one direction.

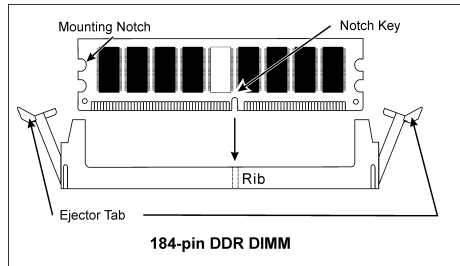

5. To remove the DIMM modules, push the two ejector tabs on the slot outward simultaneously, and then pull out the DIMM module.

ATTENTION: Static electricity can damage the electronic components of the computer or optional boards. Before starting these procedures, ensure that you are discharged of static electricity by touching a grounded metal object briefly.

2-4. Connectors, Headers and Switches

Here we will show you all of the connectors, headers and switches, and how to connect them. Please read the entire section for necessary information before attempting to finish all the hardware installation inside the computer chassis. A complete enlarged layout diagram is shown in Chapter 1 for all the position of connectors and headers on the board that you may refer to.

WARNING: Always power off the computer and unplug the AC power cord before adding or removing any peripheral or component. Failing to do so may cause severe damage to your motherboard and/or peripherals. Plug in the AC power cord only after you have carefully checked everything.

(1). ATX Power Input Connectors

This motherboard provides two power connectors to connect to an ATX12V power supply.

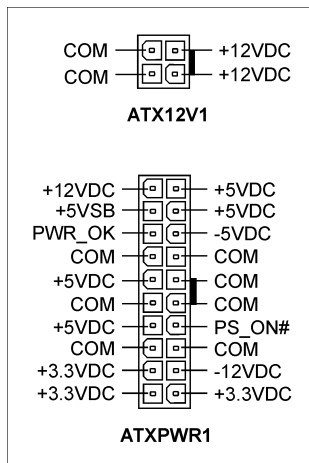
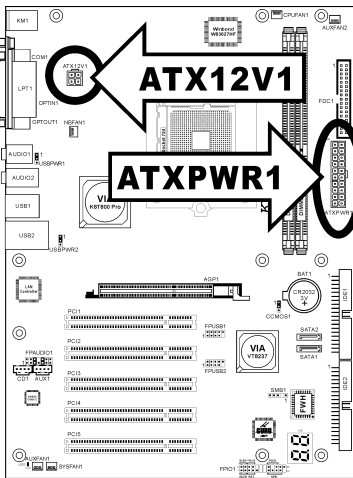

NOTE: It is recommended to connect to a power supply with 350W, 20A +5VDC capacity at least for heavily loaded system, and 2A +5VSB capacity at least for supporting wake-up features.

(2). **FAN Connectors**

These 3-pin connectors each provide power to the cooling fans installed in your system.

The CPU must be kept cool by using a powerful fan with heatsink. The system is capable of monitoring the speed of the CPU fan.

- **CPUFAN1:** CPU Fan
- **NBFAN1:** Chipset Fan
- **SYSFAN1:** System Fan
- **AUXFAN1, AUXFAN2:** Auxiliary Fan

WARNING: These fan connectors are not jumpers. DO NOT place jumper caps on these connectors.

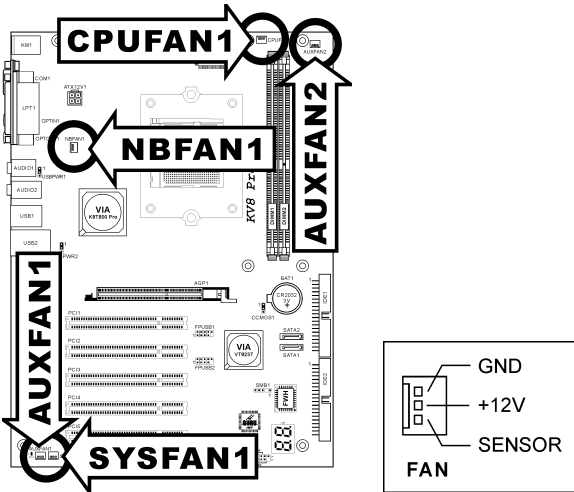

(3). CMOS Memory Clearing Header

This header uses a jumper cap to clear the CMOS memory.

- **Pin 1-2 shorted (default):** Normal operation.
- **Pin 2-3 shorted:** Clear CMOS memory.

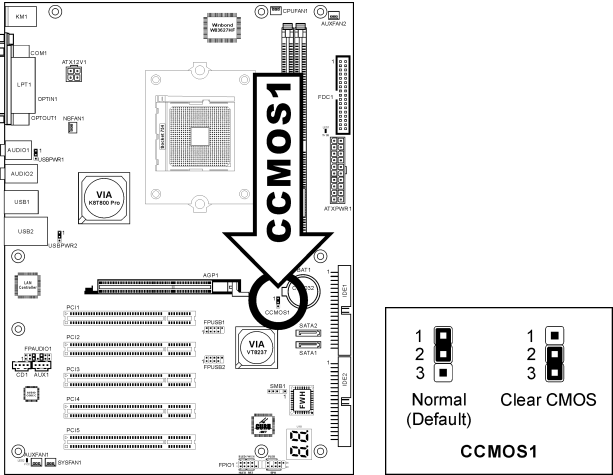

WARNING: Turn the power off first (including the +5V standby power) before clearing the CMOS memory. Failing to do so may cause your system to work abnormally or malfunction.

(4). Wake-up Header

These headers use a jumper cap to enable/disable the wake-up function.

- **USBPWR1:**
Pin 1-2 shorted (default): Disable wake-up function support at USB1 port.
Pin 2-3 shorted: Enable wake-up function support at USB1 port.
- **USBPWR2:**
Pin 1-2 shorted (default): Disable wake-up function support at USB2 port.
Pin 2-3 shorted: Enable wake-up function support at USB2 port.

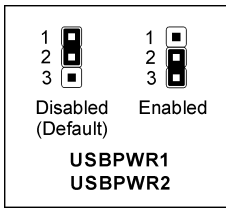
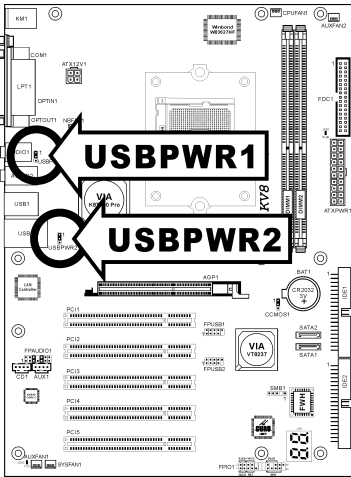

(5). Front Panel Switches & Indicators Headers

This header is used for connecting switches and LED indicators on the chassis front panel.

Watch the power LED pin position and orientation. The mark “+” align to the pin in the figure below stands for positive polarity for the LED connection. Please pay attention to connect these headers. A wrong orientation will only cause the LED not lighting, but a wrong connection of the switches could cause system malfunction.

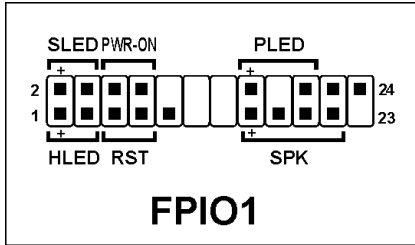
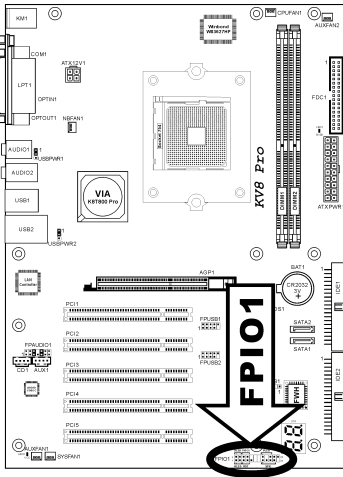

- **HLED (Pin 1, 3):**
Connects to the HDD LED cable of chassis front panel.
- **RST (Pin 5, 7):**
Connects to the Reset Switch cable of chassis front panel.
- **SPK (Pin 15, 17, 19, 21):**
Connects to the System Speaker cable of chassis.
- **SLED (Pin 2, 4):**
Connects to the Suspend LED cable (if there is one) of chassis front panel.
- **PWR-ON (Pin 6, 8):**
Connects to the Power Switch cable of chassis front panel.
- **PLED (Pin 16, 18, 20):**
Connects to the Power LED cable of chassis front panel.

(6). Additional USB Port Headers

These headers each provide 2 additional USB 2.0 ports connection through an USB cable designed for USB 2.0 specifications.

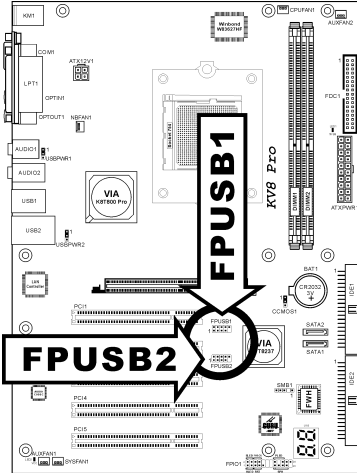

<div style="border: 1px solid black; padding: 5px; width: fit-content; margin: 0 auto;"> <p style="text-align: center;">2 4 6 8 10</p> <table border="1" style="width: 100%; height: 15px;"> <tr><td style="width: 20px;">■</td><td style="width: 20px;">■</td><td style="width: 20px;">■</td><td style="width: 20px;">■</td><td style="width: 20px;">■</td></tr> </table> <p style="text-align: center;">1 3 5 7</p> <p style="text-align: center;">FPUSB1 FPUSB2</p> </div>		■	■	■	■	■	Pin	Pin Assignment	Pin	Pin Assignment
■	■	■	■	■						
	1	VCC	2	VCC						
	3	- Data 0	4	- Data 1						
	5	+ Data 0	6	+ Data 1						
	7	Ground	8	Ground						
			10	NC						

(7). Front Panel Audio Connection Header

This header provides the connection to audio connector at front panel.

- To use the audio connector at front panel, remove all the jumpers on this header, and then connect to front panel by the extension cable provided with the chassis.
- To use the audio connector at rear panel, disconnect the extension cable, attach the jumpers back at pin 5-6, and pin 9-10 (default setting).

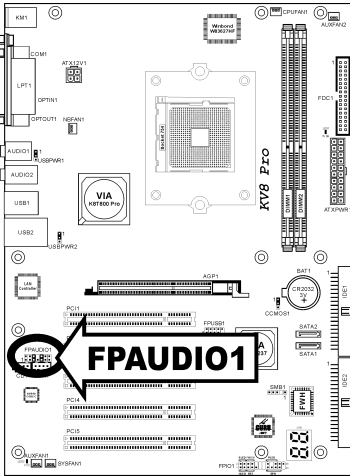

Pin	Pin Assignment	Pin	Pin Assignment
1	Audio Mic.	2	Ground
3	Audio Mic. Bias	4	VCC
5	Speaker Out Right Channel	6	Speaker Out Right Channel Return
7	X	8	NC
9	Speaker Out Left Channel	10	Speaker Out Left Channel Return
11	Ground	12	S/PDIF In
13	VCC	14	S/PDIF Out

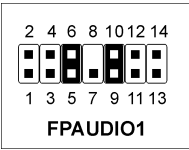

(8). Internal Audio Connectors

These connectors connect to the audio output of internal CD-ROM drive or add-on card.

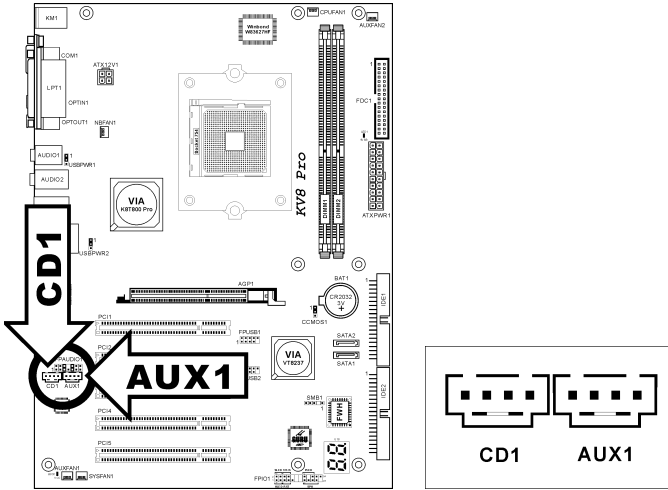

(9). Accelerated Graphics Port Slot

This slot supports an optional AGP graphics card up to AGP 8X mode. Please refer to our Web site for more information on graphics cards.

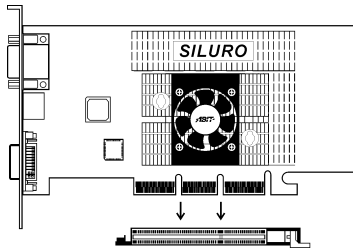
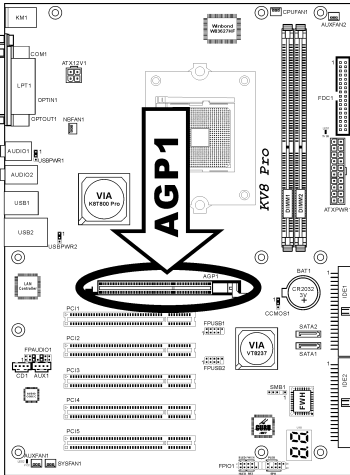

ATTENTION: This motherboard does not support 3.3V AGP cards. Use only 1.5V or 0.8V AGP cards.

(10). Floppy Disk Drive Connector

This connector supports two standard floppy disk drives via a 34-pin 34-conductor ribbon cable.

Connecting the Floppy Disk Drive Cable:

1. Install one end of the ribbon cable into the FDC1 connector. The colored edge of the ribbon cable should be aligned with pin-1 of FDC1 connector.
2. Install the other end(s) of ribbon cable into the disk drive connector(s). The colored edge of the ribbon cable should be also aligned with pin-1 of disk drive connector. The endmost connector should be attached to the drive designated as Drive A.

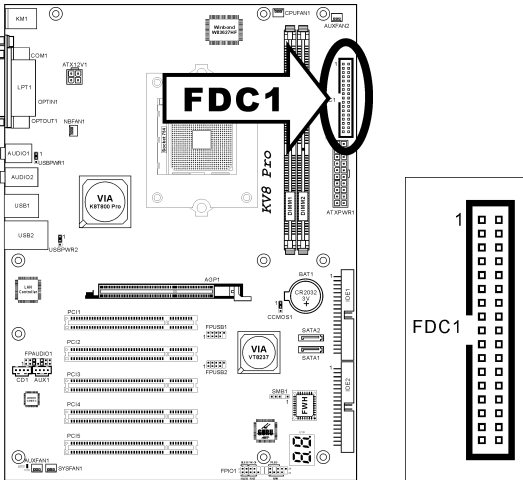

(11). IDE Connectors

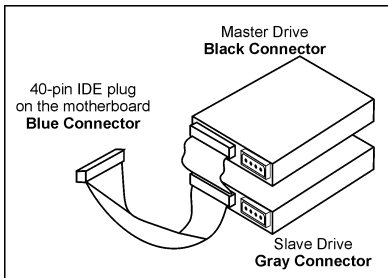
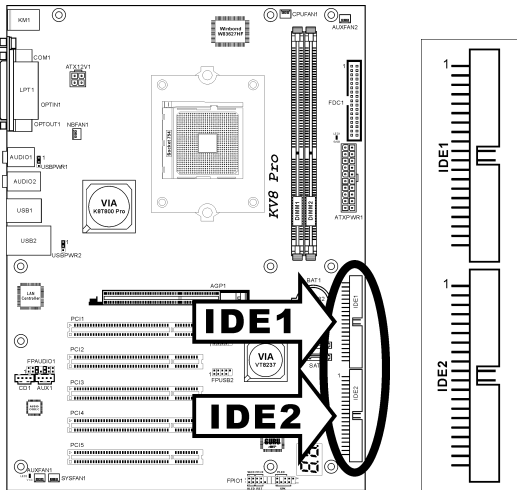

This motherboard provides two IDE ports to connect up to four IDE drives at Ultra DMA mode by Ultra ATA/66 ribbon cables. Each cable has 40-pin 80-conductor and three connectors, providing two hard drives connection with motherboard. Connect the single end (blue connector) at the longer length of ribbon cable to the IDE port on motherboard, and the other two ends (gray and black connector) at the shorter length of the ribbon cable to the connectors on hard drives.

If you want to connect two hard drives together through one IDE channel, you must configure the second drive to Slave mode after the first Master drive. Please refer to the drives' documentation for jumper settings. The first drive connected to IDE1 is usually referred to as "Primary Master", and the second drive as "Primary Slave". The first drive connected to IDE2 is referred to as "Secondary Master" and the second drive as "Secondary Slave".

Keep away from connecting one legacy slow speed drive, like CD-ROM, together with another hard drive on the same IDE channel; this will drop your integral system performance.

(12). POST Code Display

This is an LED device to display the “POST” Code, the acronym of **P**ower **O**n **S**elf **T**est. The computer will execute the POST action whenever you power on the computer. The POST process is controlled by the BIOS. It is used to detect the status of the computer’s main components and peripherals. Each POST Code corresponds to different checkpoints that are also defined by the BIOS in advance. For example, “memory presence test” is an important checkpoint and its POST Code is “C1”. When the BIOS execute any POST item, it will write the corresponding POST Code into the address 80h. If the POST passes, the BIOS will process the next POST item and write the next POST Code into the address 80h. If the POST fails, we can check the POST Code in address 80h to find out where the problem lies.

This LED device also displays the “POST” Code of AC2003, an “uGuru” chipset developed exclusively by ABIT computer.

NOTE: The decimal point lights up when executing the AC2003 POST action.

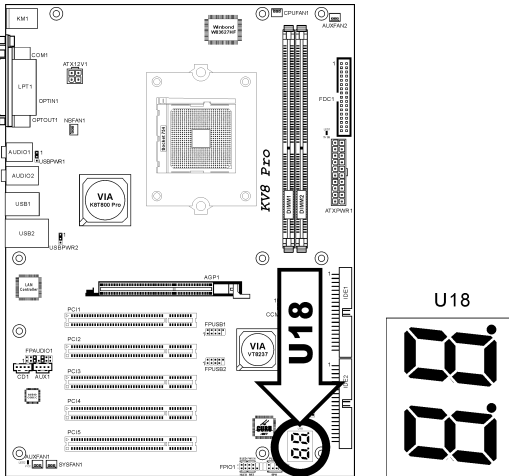

See Appendix for both AWARD and AC2003 POST Code definition.

(13). Serial ATA Connectors

These connectors are provided to attach one Serial ATA device at each channel via Serial ATA cable.

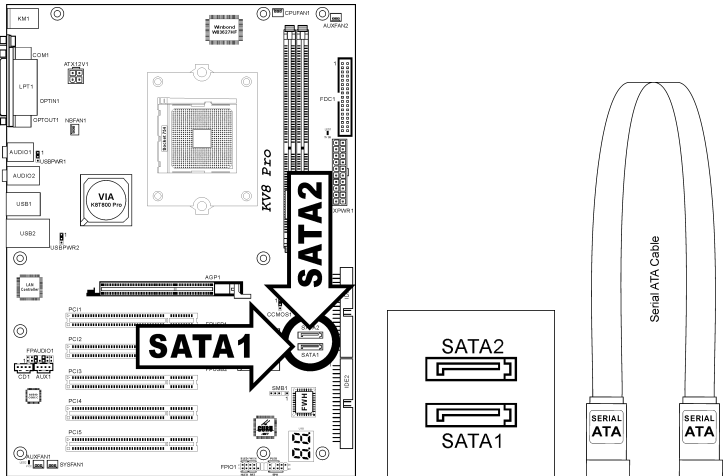

(14). Status Indicators

- **LED1 (5VSB):** This LED lights up when the power supply is connected with power source.
- **LED2 (VCC):** This LED lights up when the system power is on.

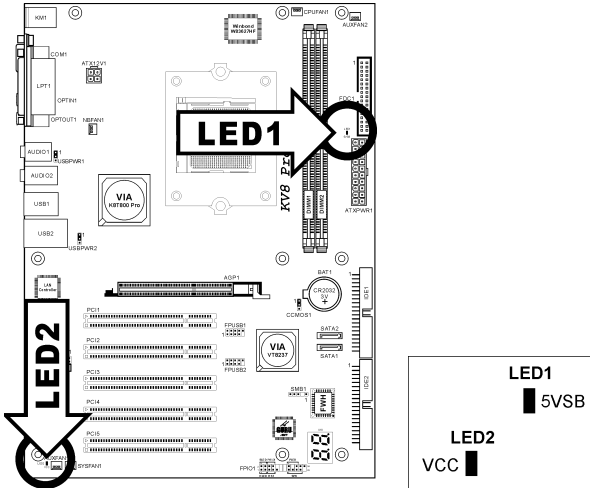

(15). System Management Bus Headers

This header is reserved for system management bus (SM bus). The SM bus is a specific implementation of an I²C bus. I²C is a multi-master bus, which means that multiple chips can be connected to the same bus and each one can act as a master by initiating a data transfer. If more than one master simultaneously tries to control the bus, an arbitration procedure decides which master gets priority.

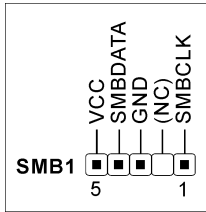
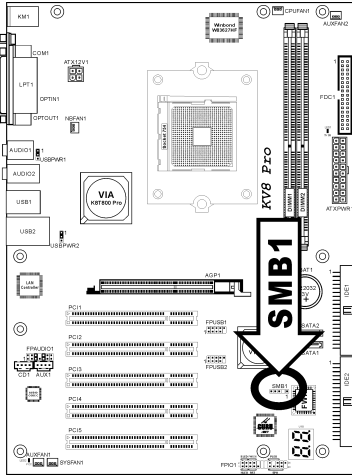

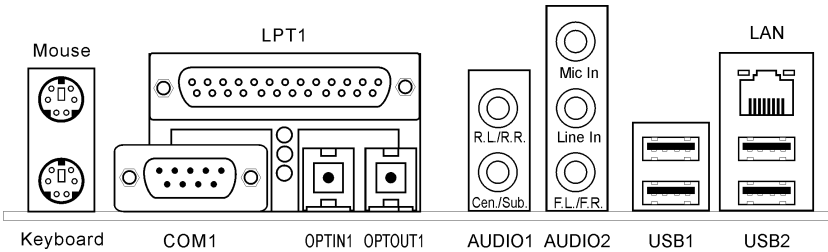
(16). Back Panel Connectors

- **Mouse:** Connects to PS/2 mouse.
- **Keyboard:** Connects to PS/2 keyboard.
- **LPT1:** Connects to printer or other devices that support this communication protocol.
- **COM1:** Connects to external modem, mouse or other devices that support this communication protocol.
- **OPTIN1:** This connector provides an S/PDIF in connection through optical fiber to digital multimedia devices.
- **OPTOUT1:** This connector provides an S/PDIF out connection through optical fiber to digital multimedia devices.
- **AUDIO1:**
 - R.L./R.R. (Rear Left / Rear Right):** Connects to the rear left and rear right channel in the 5.1 channel audio system.
 - Cen./Sub. (Center / Subwoofer):** Connects to the center and subwoofer channel in the 5.1 channel audio system.
- **AUDIO2:**
 - Mic In:** Connects to the plug from external microphone.
 - Line In:** Connects to the line out from external audio sources.
 - F.L./F.R. (Front Left / Front Right):** Connects to the front left and front right channel in the 5.1-channel or regular 2-channel audio system.
- **LAN:** Connects to Local Area Network.
- **USB1/USB2:** Connects to USB devices such as scanner, digital speakers, monitor, mouse, keyboard, hub, digital camera, joystick etc.

Chapter 3. BIOS Setup

This motherboard provides a programmable EEPROM that you can update the BIOS utility. The BIOS (Basic Input/Output System) is a program that deals with the basic level of communication between processor and peripherals. Use the BIOS Setup program only when installing motherboard, reconfiguring system, or prompted to “Run Setup”. This chapter explains the Setup Utility of BIOS utility.

After powering up the system, the BIOS message appears on the screen, the memory count begins, and then the following message appears on the screen:

PRESS DEL TO ENTER SETUP

If this message disappears before you respond, restart the system by pressing <Ctrl> + <Alt> + keys, or by pressing the Reset button on computer chassis. Only when it failed by these two methods can you restart the system by powering it off and then back on.

After pressing key, the main menu screen appears.



NOTE: In order to increase system stability and performance, our engineering staffs are constantly improving the BIOS menu. The BIOS setup screens and descriptions illustrated in this manual are for your reference only, may not completely match what you see on your screen.

In the BIOS Setup main menu, you can see several options. We will explain these options step by step in the following pages of this chapter, but let us first see a short description of the function keys you may use here.

Esc:

Press this button to quit the BIOS Setup.

↑ ↓ ← →:

Press these buttons to choose, in the main menu, the option you want to confirm or to modify.

F10:

When you have completed the setup of BIOS parameters, press this button to save these parameters and to exit the BIOS Setup menu.

F6:

You may create a profile to save the new BIOS settings in it. Press <F6> button in the main menu, a dialog box with five numbers (1~5) will appear on the screen. Select one number, and press <Enter>. Then, you will get a confirmation dialog box with a message similar to:

Save Profile To BIOS (Y/N)?

After pressing “Y”, the following message will appear to assist you in creating a name for the profile.

Enter Profile Name:

Type the profile name, and press <Enter>. The new BIOS settings now are saved to the selected profile.

NOTE: You may save up to five profiles to BIOS.

F7:

Press <F7> button in the main menu, a dialog box with five numbers (1~5) will appear on the screen. Select the profile you want, and press <Enter>. Then, you will get a confirmation dialog box with a message similar to:

Load Profile From BIOS (Y/N)?

Press “Y” to load the BIOS settings in this profile.

3-1. µGuru Utility

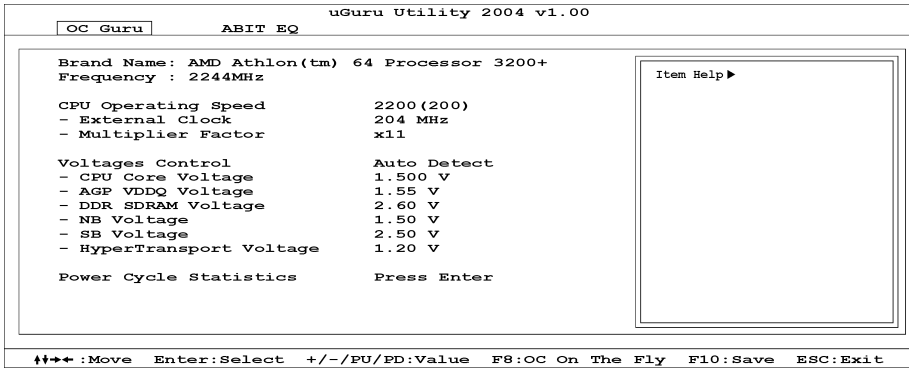

Brand Name:

This item displays the CPU model name, for example: AMD Athlon™ 64 processor 3200+.

Frequency:

This item displays the processor speed.

CPU Operating Speed:

This item displays the CPU operating speed according to the type and speed of your CPU. You can also select the [User Define] option to enter the manual option.

User Define:

WARNING: The wrong settings of the multiplier and external clock in certain circumstances may cause CPU damage. Setting the working frequency higher than the PCI chipset or processor specs, may cause abnormal memory module functioning, system hangs, hard disk drive data lose, abnormal functioning of the VGA card, or abnormal functioning with other add-on cards. Using non-specification settings for your CPU is not the intention of this explanation. These should be used for engineering testing, not for normal applications.

There will be no guaranty for the settings beyond specification, any damage of any component on this motherboard or peripherals result therein is not our responsibility.

*** External Clock:**

This item selects the external clock frequency. Due to the specification limit of the CPU you installed, the speed you set over its standard bus speed is supported, but not guaranteed.

*** Multiplier Factor:**

This item displays the multiplier factor for the CPU you installed.

NOTE: Some processors might have this multiplier factor locked, so there is no way to choose a higher multiplier factor.

Voltages Control:

This option allows you to switch between the default and user-defined voltages. Leave this setting to default unless the current voltage setting cannot be detected or is not correct. The option “**User Define**” enables you to select the following voltages manually.

* **CPU Core Voltage:**

This item selects the CPU core voltage.

* **AGP VDDQ Voltage:**

This item selects the voltage for AGP slot.

* **DDR SDRAM Voltage:**

This item selects the voltage for DRAM slot.

* **NB Voltage:**

This item selects the NB voltage.

* **SB Voltage:**

This item selects the SB voltage.

* **HyperTransport Voltage:**

This item selects the voltage for LDT Bus.

<F8> function key:

After a new configuration on items “External Clock” and “Voltage”, pressing <F8> button now in this menu will make it become effective immediately.

ATTENTION: An external clock too much over its specification may cause the system unstable or even fail, please proceed with highly attention.

Power Cycle Statistics:

Click <Enter> key to enter its submenu:

OC Guru		ABIT EQ		uGuru Utility 2004 v1.00	
Power Cycle Statistics					
PC Up Time		Hours			
PC Up Time Total		Hours			
PC Power Cycles		Cycles			
PC Reset Button Cycles		Cycles			
AC Power On Total Time		Hours			
AC Power Cycles		Cycles			

↑↓↓←:Move Enter:Select +/-/PU/PD:Value F8:OC On The Fly F10:Save ESC:Exit

These items display the power cycle statistics for each element.

↩ Back to µGuru Utility Setup Menu:

Use <←> key to switch from OC Guru setup menu to ABIT EQ setup menu:

OC Guru		uGuru Utility 2004 v1.00	
	ABIT EQ		
ABIT EQ Beep Control	Enabled		
Temperature Monitoring	Press Enter		
Voltage Monitoring	Press Enter		
Fan Speed Monitoring	Press Enter		
FanEQ Control	Press Enter		
↑↑←:Move Enter>Select +/-/PU/PD:Value F10:Save ESC:Exit			

ABIT EQ Beep Control:

This item allows you to enable or disable ABIT EQ Beep Control function.

↩ Temperature Monitoring:

Click <Enter> key to enter its submenu:

OC Guru		uGuru Utility 2004 v1.00	
	ABIT EQ		
	Temperature Monitoring		
	Reading	Shutdown Enable	Shutdown Temp.
		Beep Enable	Beep Temp.
(*) CPU Temperature	42°C/107°F	()	85°C/185°F
(*) System Temperature	30°C/86°F	()	65°C/149°F
(*) PWM Temperature	36°C/96°F	()	90°C/194°F
↑↑←:Move Enter>Select +/-/PU/PD:Value F10:Save ESC:Exit			

CPU Temperature/System Temperature/PWM Temperature:

These items display the temperature of CPU, System, and Power Module.

* Shutdown Enable:

Use <Space> key to enable system shutdown function. If the CPU/System/PWM's temperature exceeds the shutdown temperature limit, the system would shutdown automatically.

* Shutdown Temp.:

This item sets the temperature that would shutdown the system automatically in order to prevent system overheats.

* Beep Enable:

Use <Space> key to enable warning beeps function. Once the system has detected that the CPU/System/PWM's temperature exceeded the beep temperature limit, warning beeps will sound.

* Beep Temp.:

This item selects the warning temperature limit.

NOTE: The shutdown temperature must be set above the warning temperature.

Voltage Monitoring:

Click <Enter> key to enter its submenu:

OC Guru		uGuru Utility 2004 v1.00				
		ABIT EQ				
		Voltage Monitoring				
	Reading	Shutdown Enable	Beep Enable	High Limit	Low Limit	
(*) CPU Core Voltage	1.537V	()	()	1.80 V	1.00 V	
(*) DDR Voltage	2.67V	()	()	3.10 V	2.10 V	
(*) DDR VTT Voltage	1.34V	()	()	1.55 V	1.05 V	
(*) NB Voltage	1.59V	()	()	1.80 V	1.20 V	
(*) SB Voltage	2.59V	()	()	3.00 V	2.00 V	
(*) HyperTransport Voltage	1.24V	()	()	1.45 V	0.95 V	
(*) AGP VDDQ Voltage	1.60V	()	()	1.85 V	1.25 V	
(*) ATX +5V	5.13V	()	()	6.00 V	4.00 V	
(*) ATX +3.3V	3.36V	()	()	3.95 V	2.65 V	
(*) Standby Voltage (+5V)	5.18V	()	()	6.00 V	4.00 V	
(*) 3VDual Voltage	3.34V	()	()	3.95 V	2.65 V	

↑↑→← :Move Enter:Select +/-/PU/PD:Value F10:Save ESC:Exit

All Voltages:

These items display the voltage of each element.

* Shutdown Enable:

Use <Space> key to enable system shutdown function. If the voltage of corresponding element is higher/lower than the high/low limit, the system would automatically shutdown.

* Beep Enable:

Use <Space> key to enable warning beeps function. If the voltage of corresponding element is higher/lower than the high/low limit, warning beeps will sound.

* High/Low Limit:

These items set the high and low voltage limit.

NOTE: The value of high limit must be set above the one of low limit.

↩ Fan Speed Monitoring:

Click <Enter> key to enter its submenu:

uGuru Utility 2004 v1.00				
OC Guru		ABIT EQ		
Fan Speed Monitoring				
	Reading	Shutdown Enable	Beep Enable	Low Limit
(*) CPU FAN Speed	5340RPM	(*)	(*)	1200 RPM
() NB FAN Speed	5160RPM	()	()	1200 RPM
() SYS FAN Speed	N/A	()	()	1200 RPM
() AUX1 FAN Speed	N/A	()	()	1200 RPM
() AUX2 FAN Speed	N/A	()	()	1200 RPM

↑↓→←:Move Enter:Select +/-/PU/PD:Value F10:Save ESC:Exit

CPU/NB/SYS/AUX1/AUX2 FAN Speed:

These items display the speed of the fans connected to CPU, NB, SYS, AUX1 and AUX2 FAN headers.

* **Shutdown Enable:**

Use <Space> key to enable system shutdown function. Once the system has detected that the fan speed is lower than the low limit value, system will shutdown automatically.

* **Beep Enable:**

Use <Space> key to enable warning beeps function. If the fan speed is lower than the low limit value, warning beeps will sound.

* **Low Limit:**

These items set the low limit of fan speed.

NOTE: Only the fans with 3-pin plugs provide the speed monitoring function.

↩ FanEQ Control:

Click <Enter> key to enter its submenu:

uGuru Utility 2004 v1.00	
OC Guru	ABIT EQ
	FanEQ Control
CPU FanEQ Control	Enabled
- Reference Temperature	CPU Temperature
- Control Temperature High	65°C/149°F
- Control Temperature Low	35°C/95°F
- DC Fan Voltage High	12.0 V
- DC Fan Voltage Low	8.0 V
NB FanEQ Control	Disabled
SYS FanEQ Control	Disabled
	Item Help ▶
↑↓→←:Move Enter:Select +/-/PU/PD:Value F10:Save ESC:Exit	

CPU/NB/SYS FanEQ Control:

When set to [Enabled], these items allow you to control the CPU/NB/System fan speed by its setting combination of temperature and voltage high/low limit.

* Reference Temperature:

These items display the CPU/NB/System temperature.

* Control Temp. High/Low:

These items set the high and low temperature limit that you want to do the fan speed control.

* DC Fan Voltage High/Low:

These items set the high and low voltage limit that you want to provide the fan with.

NOTE: The value of high limit must be set above the one of low limit.

3-2. Standard CMOS Features

This section contains the basic configuration parameters of the BIOS. These parameters include date, hour, VGA card, FDD and HDD settings.



Date (mm:dd:yy):

This item sets the date you specify (usually the current date) in the format of [Month], [Date], and [Year].

Time (hh:mm:ss):

This item sets the time you specify (usually the current time) in the format of [Hour], [Minute], and [Second].

IDE Channel 1 Master / Slave, IDE Channel 2 Master / Slave:

Click <Enter> key to enter its submenu:

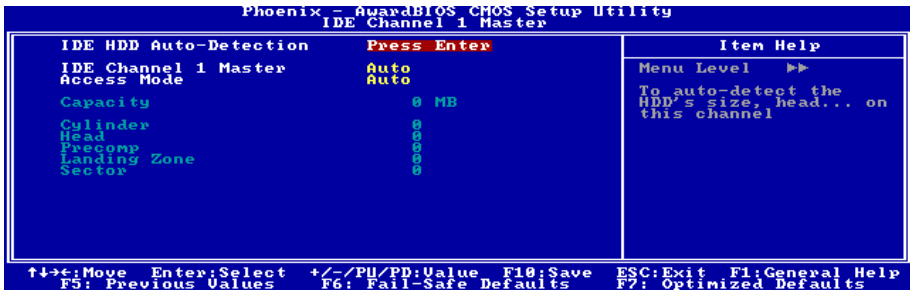

IDE HDD Auto-Detection:

This item allows you to detect the parameters of IDE drives by pressing <Enter> key. The parameters will be shown on the screen automatically.

IDE Channel 1 Master / Slave, IDE Channel 2 Master / Slave:

When set to [Auto], the BIOS will automatically check what kind of IDE drive you are using. If you want to define your own drive by yourself, set it to [Manual] and make sure you fully understand the meaning of the parameters. Please refer to the instruction manual provided by the device's manufacturer to get the setting right.

Access Mode:

This item selects the mode to access your IDE devices. Leave this item to its default [Auto] setting to detect the access mode of your HDD automatically.

Capacity:

This item displays the approximate capacity of the disk drive. Usually the size is slightly greater than the size of a formatted disk given by a disk-checking program.

Cylinder:

This item configures the numbers of cylinders.

Head:

This item configures the numbers of read/write heads.

Precomp:

This item displays the number of cylinders at which to change the write timing.

Landing Zone:

This item displays the number of cylinders specified as the landing zone for the read/write heads.

Sector:

This item configures the numbers of sectors per track.

 **Back to Standard CMOS Features Setup Menu:**

Drive A & Drive B:

This item sets the type of floppy drives (usually only Drive A) installed.

Floppy 3 Mode Support:

This item allows you to use "3 Mode Floppy Drive" in Japanese computer system by selecting drive A, B, or both. Leave this item to its default [Disabled] setting if you are not using this Japanese standard floppy drive.

Video:

This item selects the type of video adapter used for the primary system monitor.

[EGA/VGA]: (Enhanced Graphics Adapter/Video Graphics Array) For EGA, VGA, SVGA and PGA monitor adapters.

[CGA 40]: (Color Graphics Adapter) Power up in 40-column mode.

[CGA 80]: (Color Graphics Adapter) Power up in 80-column mode.

[Mono]: (Monochrome adapter) Includes high-resolution monochrome adapters.

Halt On:

This item determines whether the system stops if an error is detected during system boot-up.

[All Errors]: The system-boot will stop whenever the BIOS detect a non-fatal error.

[No Errors]: The system-boot will not stop for any error detected.

[All, But Keyboard]: The system-boot will stop for all errors except a keyboard error.

[All, But Diskette]: The system-boot will stop for all errors except a diskette error.

[All, But Disk/Key]: The system-boot will stop for all errors except a diskette or keyboard error.

Base Memory:

This item displays the amount of base memory installed in the system. The value of the base memory is typically 640K for system with 640K or more memory size installed on the motherboard.

Extended Memory:

This item displays the amount of extended memory detected during system boot-up.

Total Memory:

This item displays the total memory available in the system.

3-3. Advanced BIOS Features



Hard Disk Boot Priority:

This item selects the hard disks booting priority. By pressing <Enter> key, you can enter its submenu where the hard disks detected can be selected for the booting sequence to boot up system.

This item functions only when there is the option of [Hard Disk] in any one of the First/Second/Third Boot Device items.

* **Bootable Add-in Device:**

This item allows you to select the add-in device priority between [PCI Slot Device] and [Onchip SATA RAID]. Onchip SATA RAID means VIA SATA RAID.

First Boot Device / Second Boot Device / Third Boot Device / Boot Other Device:

Select the drive to boot first, second and third in the [First Boot Device], [Second Boot Device], and [Third Boot Device] items respectively. The BIOS will boot the operating system according to the sequence of the drive selected. Set [Boot Other Device] to [Enabled] if you wish to boot from another device other than these three items.

Swap Floppy Drive:

When set to [Enabled], and the system is booting from the floppy drive, the system will boot from drive B instead of the regular drive A. There must be two floppy drives connected in the system to use this function.

Boot Up NumLock Status:

This item determines the default state of the numeric keypad at system booting up.

[On]: The numeric keypad functions as number keys.

[Off]: The numeric keypad functions as arrow keys.

Security Option:

This item determines when the system will prompt for password - every time the system boots or only when enters the BIOS setup.

[Setup]: The password is required only when accessing the BIOS Setup.

[System]: The password is required each time the computer boots up.

NOTE: Don't forget your password. If you forget the password, you will have to open the computer case and clear all information in the CMOS before you can start up the system. But by doing this, you will have to reset all previously set options.

MPS Version Ctrl For OS:

This item specifies which version of MPS (Multi-Processor Specification) this motherboard will use. The options are 1.1 and 1.4. The default setting is **1.4**. If you use an older OS for dual processor executing, please set this option to 1.1.

Report No FDD For OS:

When set to [Enabled], this item allows you to run some older operating system without floppy disk drive. Leave this item to its default setting.

Delay IDE Initial (Secs):

This item allows the BIOS to support some old or special IDE devices by prolonging this delay time. A larger value will give more delay time to the device for which to initialize and to prepare for activation.

Full Screen LOGO Show:

This item determines to show the full screen logo when booting.

Disable unused PCI Clock:

This option disables the clock of PCI slot that is not in use.

[Enabled]: The system automatically detect the unused PCI slots, and stop sending clock signal to these unused PCI slots.

[Disabled]: The system always send clock signal to all PCI slots.

NOTE: Set this option to [Disabled] setting if there are adapters that cannot be automatically detected by the system and will cause malfunction.

3-4. Advanced Chipset Features



AGP & P2P Bridge Control:

Click <Enter> key to enter its submenu:



AGP Aperture Size:

This option specifies the amount of system memory that can be used by the AGP device. The aperture is a portion of the PCI memory address range dedicated for graphics memory address space.

AGP 2.0 Mode:

This item selects the data transfer rate of AGP device. A higher rate delivers faster and better graphics to your system. Make sure your graphics card supports the mode you select.

AGP Driving Control:

Leave this item to its default setting.

* AGP Driving Value:

Leave this item to its default setting.

AGP Fast Write:

Two options are available: Disabled → Enabled. The default setting is *Enabled*. If your AGP adapter can support this function, then you can choose *Enabled*. Otherwise, choose *Disabled*.

AGP Master 1 WS Write:

Two options are available: Disabled → Enabled. The default setting is *Disabled*. This implements a single delay when writing to the AGP Bus. When you set it to *Enabled*, two-wait states are used by the system, allowing for greater stability.

AGP Master 1 WS Read:

Two options are available: Disabled → Enabled. The default setting is *Disabled*. This implements a single delay when reading to the AGP Bus. When you set it to *Enabled*, two-wait states are used by the system, allowing for greater stability.

AGP 3.0 Calibration cycle:

Leave this item to its default setting.

DBI Output for AGP Trans.:

Leave this item to its default setting.

↩ **Back to Advanced Chipset Features Setup Menu:**

DRAM Configuration:

Click <Enter> key to enter its submenu:

```

Phoenix - AwardBIOS CMOS Setup Utility
DRAM Configuration
Current FSB Frequency      200 MHz
Current DRAM Frequency    300 MHz
DRAM Timing Selectable    By SPD
- DRAM Clock               DDR400
- CAS Latency Time        6.5
- RAS# to CAS# Delay      3 Cycles
- Min. RAS# Active Time   3 Cycles
- RAS# Precharge Time     3 Cycles
- Row Cycle Time          100 Cycles
- Row Refresh Cycle Time  100 Cycles
- RAS# to RAS# Delay      4 Cycles
- Write Recovery Time     4 Cycles
- Write to Read Delay     4 Cycles
- Read to Write Delay     4 Cycles

```

Item Help	
Menu Level	▶▶
DRAM Timing Setting By SPD or ITEM	

```

↑↓←→:Move  Enter:Select  +/-/PU/PD:Value  F10:Save  ESC:Exit  F1:General Help
F5: Previous Values  F6: Fail-Safe Defaults  F7: Optimized Defaults

```

Current FSB Frequency:

This item will show you the current system front side bus speed.

Current DRAM Frequency:

This item will show you the current DRAM bus speed.

DRAM Timing Selectable:

Two options are available: Manual → By SPD. The default setting is *By SPD*. When set to “**By SPD**”, the BIOS will read the DRAM module SPD data and automatically set to the values stored in it.

*** DRAM Clock:**

This item sets the DRAM clock of your DRAM module. The system may be unstable or unable to boot up if your DRAM module does not support the clock you set.

When set to [By SPD], the BIOS will read the DRAM module SPD data and automatically set the DRAM clock by the value stored in it.

*** CAS Latency Time:**

Three options are available: 2 → 2.5 → 3. The default setting is 2.5. You can select SDRAM CAS (Column Address Strobe) latency time according your SDRAM specification.

*** RAS# to CAS# Delay:**

This item specifies the RAS# active to CAS# read write delay time to the same bank.

*** Min. RAS# Active Time:**

This item specifies the minimum RAS# active time.

*** RAS# Precharge Time:**

This item specifies the RAS# precharge time.

*** Row Cycle Time:**

This item specifies the RAS# active to RAS# active time or auto refresh time of the same bank.

*** Row Refresh Cycle Time:**

This item specifies the auto refresh active to RAS# active time or RAS# auto refresh time.

*** RAS# to RAS# Delay:**

This item specifies the RAS# active to RAS# active delay time of different bank.

*** Write Recovery Time:**

This item specifies the time measured from the last write datum is safely registered by the DRAM.

*** Write to Read Delay:**

This item specifies the time measured from the rising edge following the last non-masked data strobe to the rising edge of the next read command.

*** Read to Write Delay:**

This item specifies the read to write delay.

↩ Back to Advanced Chipset Features Setup Menu:

LDT & PCI Bus Control:

Click <Enter> key to enter its submenu:

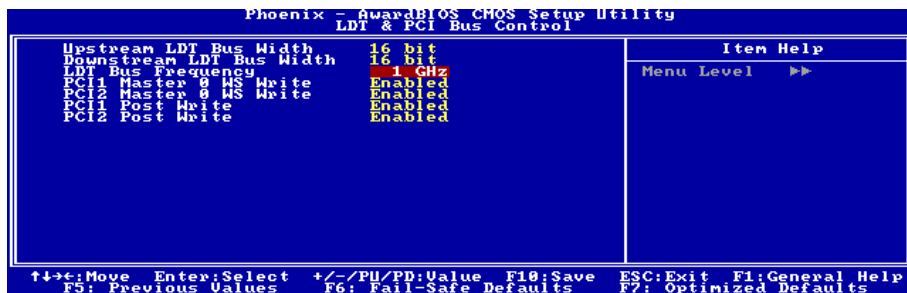

Upstream/Downstream LDT Bus Width:

This item allows you to select LDT Bus Width.

LDT Bus Frequency:

This item allows you to select LDT Bus Frequency.

PCI1/PCI2 Master 0 WS Write:

Two options are available: Enabled or Disabled. The default setting is *Enabled*. When *Enabled*, writes to the PCI bus are executed with zero wait state (immediately) when PCI bus is ready to receive data. If it is set to *Disabled*, the system will wait one state before data is written to the PCI bus.

PCI1/PCI2 Post Write:

Two options are available: Enabled or Disabled. The default is *Enabled*. When *Enable*, data transmission from CPU to PCI bus are buffered and compensate for the different speed between CPU and PCI bus. If it is set to *Disabled*, data transmissions are not buffered and CPU must wait until the data transmission is complete and then start another transmission cycle.

↩ Back to Advanced Chipset Features Setup Menu:

Memory Hole:

When set to [15M–16M], the memory address space at 15M-16M will be reserved for ISA expansion cards that specifically requires this setting. This makes the memory from 15MB and up unavailable to the system. Leave this item to its default setting.

Vlink Data Rate:

This item can let you select the Vlink Data Rate between northbridge and southbridge.

3-5. Integrated Peripherals



OnChip IDE Device:

Click <Enter> key to enter its submenu:

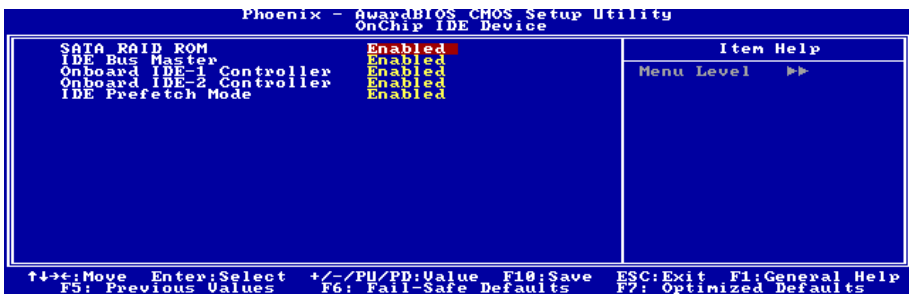

SATA RAID ROM:

This item allows you to use the boot ROM of on-chip Serial ATA RAID to boot-up system.

IDE Bus Master:

This option enables or disables the IDE bus mastering capability under the DOS environment.

Onboard IDE-1/IDE-2 Controller:

This item allows you to enable or disable the primary and secondary IDE controller. Select [Disabled] if you want to add a different hard drive controller.

IDE Prefetch Mode:

Two options are available: Disabled or Enabled. The default setting is *Enabled*. The onboard IDE drive interfaces supports IDE prefetching for faster drive accesses. If you install a primary and/or secondary add-in IDE interface, set this field to *Disabled* if the interface does not support prefetching.

↩ Back to Integrated Peripherals Setup Menu:

OnChip PCI Device:

Click <Enter> key to enter its submenu:



OnChip Audio Controller:

This option enables or disables the audio controller.

Onboard LAN Controller:

This option enables or disables the LAN controller.

* LAN Boot ROM:

This item enables or disables the Boot ROM on LAN controller.

OnChip USB Controller:

This option enables or disables the USB controller.

* USB 2.0 Controller:

This option enables or disables the USB 2.0 controller.

* USB Keyboard Support:

This item allows you to select [BIOS] for using USB keyboard in DOS environment, or [OS] in OS environment.

* USB Mouse Support:

This item allows you to select [BIOS] for using USB mouse in DOS environment, or [OS] in OS environment.

↳ Back to Integrated Peripherals Setup Menu:

SuperIO Device:

Click <Enter> key to enter its submenu:



Onboard FDD Controller:

Two options are available: Enabled and Disabled. The default setting is *Enabled*. You can enable or disable the onboard FDD controller.

Onboard Serial Port 1:

This is used to specify the I/O address and IRQ of Serial Port 1. Six options are available: Disabled → 3F8/IRQ4 → 2F8/IRQ3 → 3E8/IRQ4 → 2E8/IRQ3 → AUTO. The default setting is *3F8/IRQ4*.

Onboard Parallel Port:

Sets the I/O address and IRQ of the onboard parallel port. Four options are available: Disabled → 378/IRQ7 → 278/IRQ5 → 3BC/IRQ7. Default setting is *378/IRQ7*.

* **Parallel Port Mode:**

Four options are available: SPP → EPP → ECP → ECP+EPP.

* **EPP Mode Select:**

Two options are available: EPP1.7 → EPP1.9. When the mode selected for the parallel port mode is EPP, the two EPP version options are available.

* **ECP Mode Use DMA:**

Two options are available: 1 → 3. The default setting is 3. When the mode selected for the parallel port mode is ECP, the DMA channel selected can be Channel 1 or Channel 3.

↳ Back to Integrated Peripherals Setup Menu:

Init Display First:

This item selects to initialize AGP or PCI Slot first when the system boots.

[PCI Slot]: When the system boots, it will first initialize PCI.

[AGP]: When the system boots, it will first initialize AGP.

3-6. Power Management Setup

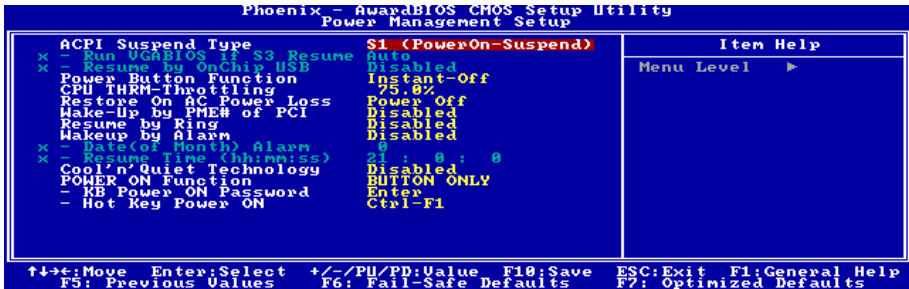

ACPI Suspend Type:

This item selects the type of Suspend mode.

[S1(PowerOn-Suspend)]: Enables the Power On Suspend function.

[S3(Suspend-To-RAM)]: Enables the Suspend to RAM function.

* Run VGABIOS if S3 Resume:

Three options are available: Auto → Yes → No. The default setting is Auto. This item can let you choose when S3 resume active, the VGA BIOS need to be initiative or not.

* Resume by OnChip USB:

Two options are available: Disabled or Enabled. The default setting is *Disabled*. When set to *Enabled*, any event affecting from onchip USB will awaken a system that has powered down. This item can be configured only if the item “ACPI Suspend Type” is set to [S3(STR)].

Power Button Function:

This item selects the method of powering off your system:

[Delay 4 Sec.]: Pushing the power button for more than 4 seconds will power off the system. This will prevent the system from powering off in case you accidentally hit or pushed the power button.

[Instant-Off]: Pressing and then releasing the power button at once will immediately power off the system.

CPU THRM-Throttling:

This item controls the CPU speed by cutting down its regular power to a percentage during the STR (Suspend To RAM) state.

Restore On AC Power Loss:

This item selects the system action after an AC power failure.

[Power Off]: When power returns after an AC power failure, the system's power remains off. You must press the Power button to power-on the system.

[Power On]: When power returns after an AC power failure, the system's power will be powered on automatically.

[Last State]: When power returns after an AC power failure, the system will return to the state where you left off before power failure occurs. If the system's power is off when AC power failure occurs, it will remain off when power returns. If the system's power is on when AC power failure occurs, the system will power-on when power returns.

Wakeup by PME# of PCI:

Two options are available: Disabled or Enabled. The default setting is *Disabled*. When set to *Enabled*, any event affecting from PCI card (PME) will awaken a system that has powered down.

Resume by Ring:

Two options are available: Disabled or Enabled. The default setting is *Disabled*. When set to *Enabled*, any event affecting from Modem Ring will awaken a system that has powered down.

Wakeup by Alarm:

Two options are available: Disabled or Enabled. The default setting is *Disabled*. When set to *Enabled*, you can set the date and time at which the RTC (real-time clock) alarm awakens the system from Suspend mode.

*** Date (of Month) Alarm / Resume Time (hh:mm:ss):**

You can set the Date (month) Alarm and Time Alarm (hh:mm:ss). Any event occurring will awaken a system that has powered down.

Cool'n'Quiet Technology:

This option enables or disables the AMD K8 cool and quiet function.

POWER ON Function:

This item selects the way you want your system to power on.

[Password]: Use a password to power on the system, select this option then press <Enter>. Enter your password. You can enter up to 5 characters. Type in exactly the same password to confirm, and then press <Enter>.

[Hot KEY]: Use any of the function keys between <F1> to <F12> to power on the system.

[Mouse Left]: Double click the mouse left button to power on the system.

[Mouse Right]: Double click the mouse right button to power on the system.

[Any KEY]: Use any keyboard keys to power on the system.

[BUTTON ONLY]: Use only the power button to power on the system.

[Keyboard 98]: Use the power-on button on the "Keyboard 98" compatible keyboard to power on the system.

NOTE: To enable this “Power On” function, the wake-up header of [USBPWR1] and [USBPWR2] must be set to [Enabled] position. Please refer to the configuration of “Wake-up Header” [USBPWR1] and [USBPWR2] in section 2-4, chapter 2.

The mouse wake up function can only be used with the PS/2 mouse, not with the COM port or USB type. Some PS/2 mice cannot wake up the system because of compatible problems. If the specs of your keyboard are too old, it may fail to power on.

※ **KB Power ON Password:**

This item sets the password required in order to power on your computer.

NOTE: Do not forget your password, or you will have to clear the CMOS and reset all parameters in order to utilize this function again.

※ **Hot Key Power ON:**

This item powers on the system by pressing <Ctrl> key plus one of each function key (<F1> ~ <F12>) simultaneously.

3-7. PnP/PCI Configurations



Resources Controlled By:

This item configures all of the boot and Plug-and-Play compatible devices.

[Auto(ESCD)]: The system will automatically detect the settings.

[Manual]: Choose the specific IRQ resources in the “IRQ Resources” menu.

* **IRQ Resources:**

Click <Enter> key to enter its submenu:

This item sets each system interrupt to either [PCI Device] or [Reserved].

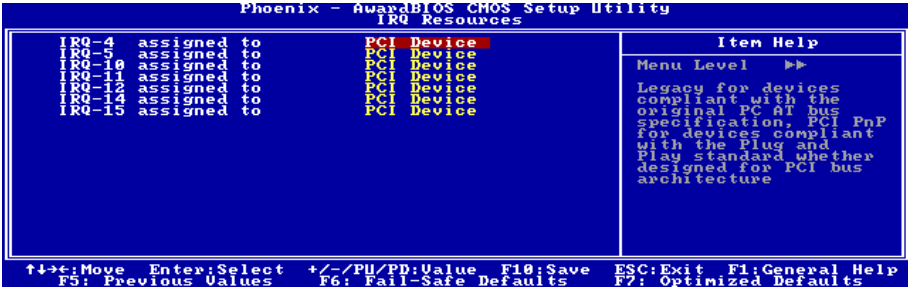

↪ **Back to PnP/PCI Configurations Setup Menu:**

PCI/VGA Palette Snoop:

This item determines whether the MPEG ISA/VESA VGA cards can work with PCI/VGA or not.

[Enabled]: MPEG ISA/VESA VGA cards work with PCI/VGA.

[Disabled]: MPEG ISA/VESA VGA cards do not work with PCI/VGA.

PIRQ 0 Use IRQ No. ~ PIRQ 7 Use IRQ No.:

This item specifies the IRQ number manually or automatically for the devices installed on PCI slots.

For the relations between the hardware layout of PIRQ (the signals from the VIA VT8237 chipset), INT# (means PCI slot IRQ signals) and devices, please refer to the table below:

Signals	AGP	LAN	PCI-1	PCI-2	PCI-3	PCI-4	PCI-5	SATA
PIRQ_0 Assignment	INT A		INT A	INT D	INT C	INT B		
PIRQ_1 Assignment	INT B		INT B	INT A	INT D	INT C		
PIRQ_2 Assignment			INT C	INT B	INT A	INT D		
PIRQ_3 Assignment			INT D	INT C	INT B	INT A		
PIRQ_4 Assignment							INT A	
PIRQ_5 Assignment							INT B	INT A
PIRQ_6 Assignment		INT A					INT C	
PIRQ_7 Assignment							INT D	

NOTE:

- PCI slot 1 shares IRQ signals with AGP slot.
- If you want to install two PCI cards into those PCI slots that share IRQ with one another at the same time, you must make sure that your OS and PCI devices' driver supports the IRQ sharing function.

3-8. Load Fail-Safe Defaults

This option loads the BIOS default values for the most stable, minimal-performance system operations.

3-9. Load Optimized Defaults

This option loads the BIOS default values that are factory settings for optimal-performance system operations.

3-10. Set Password

This option protects the BIOS configuration or restricts access to the computer itself.

3-11. Save & Exit Setup

This option saves your selections and exits the BIOS setup menu.

3-12. Exit Without Saving

This option exits the BIOS setup menu without saving any change.

Appendix A. Install VIA 4-in-1 Driver

NOTE: Please install this VIA 4-in-1 driver first after having installed the Windows operating system.

The installation procedures and screen shots in this section are based on Windows XP operating system. For those of other OS, please follow its on-screen instruction.

Insert the Driver & Utility CD into CD-ROM drive, it should execute the installation program automatically. If not, double-click the execution file at the main directory of this CD to enter the installation menu.

After entering the installation menu, move your cursor to [Drivers] tab. Click [VIA 4in1 Driver]. The following screen appears.

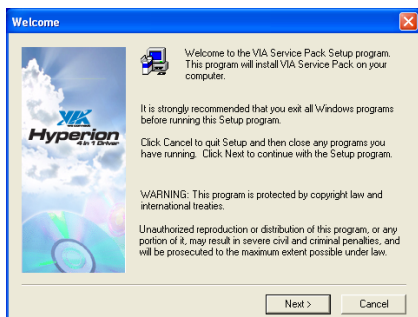

1. Click [Next].

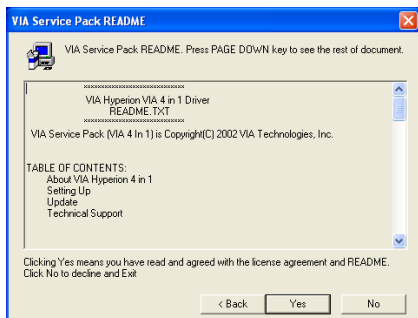

2. Click [Yes].

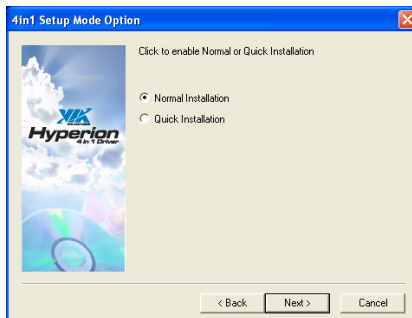

3. Click [Next].

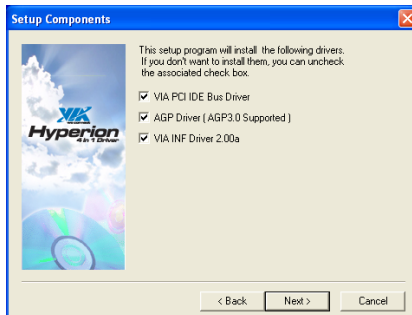

4. Click [Next].

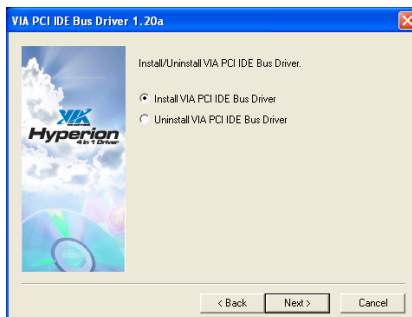

5. Click [Next].

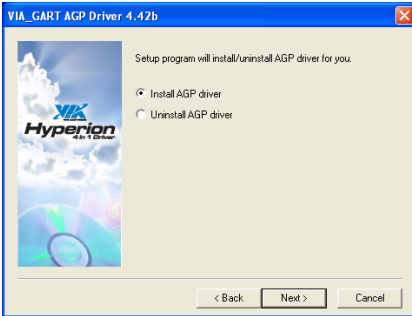

6. Click [Next].



7. Choose [Yes, I want to restart my computer now.], and click [OK] to complete setup.

Appendix B. Install Audio Driver

The installation procedures and screen shots in this section are based on Windows XP operating system. For those of other OS, please follow its on-screen instruction.

Insert the Driver & Utility CD into CD-ROM drive, it should execute the installation program automatically. If not, double-click the execution file at the main directory of this CD to enter the installation menu.

After entering the installation menu, move your cursor to [Drivers] tab. Click [Audio Driver]. The following screen appears.

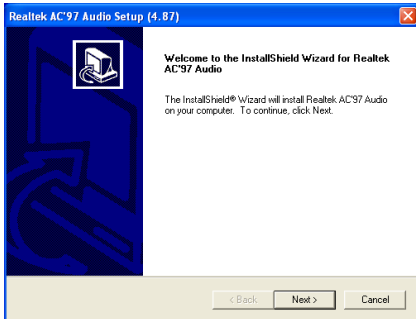

1. Click [Next].

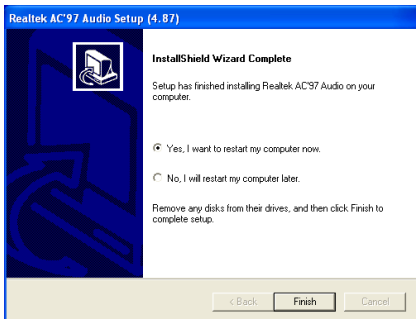

2. Choose [Yes, I want to restart my computer now.], and click [Finish] to complete setup.

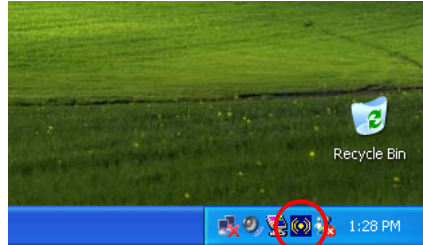

3. After the system restarted, a shortcut icon appears at the right corner of Windows task bar.



4. In this Speaker Configuration tab, select [6 channels mode for 5.1 speakers output] to enable 6-channel audio system



Appendix C. Install LAN Driver

To install the LAN driver, please insert the Driver & Utility CD into CD-ROM drive. It should execute the installation program automatically. If not, double-click the execution file at the main directory of this CD to enter the installation menu. The following screen appears.

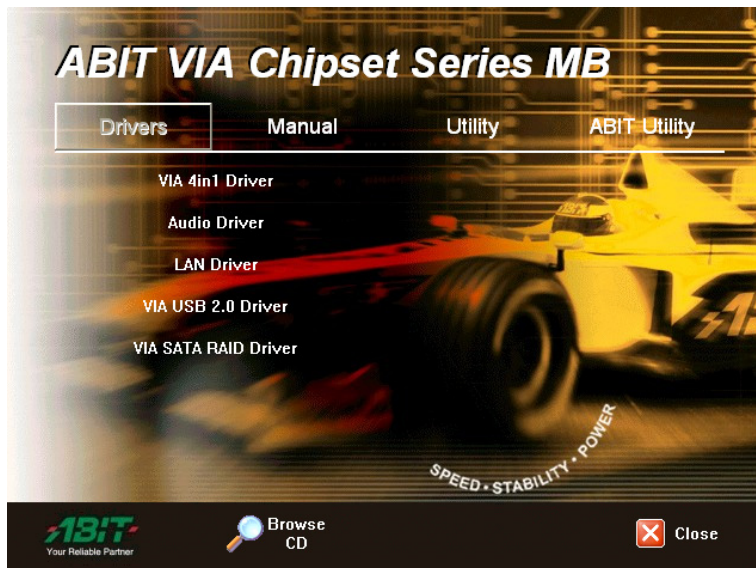

Click [LAN Driver], and then follow the on-screen instruction to complete the driver installation.



Appendix D. Install VIA USB 2.0 Driver

NOTE: There is no need to install VIA USB 2.0 driver for the Windows XP operating system with Service Pack 1 already installed. Please run the Windows update for the latest Service Pack.

The installation procedures and screen shots in this section are based on Windows 2000 operating system. For those of other OS, please follow its on-screen instruction.

Insert the Driver & Utility CD into CD-ROM drive, it should execute the installation program automatically. If not, double-click the execution file at the main directory of this CD to enter the installation menu.

After entering the installation menu, move your cursor to [Drivers] tab. Click [VIA USB 2.0 Driver]. The following screen appears.

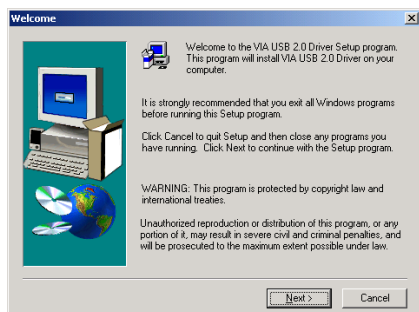

1. Click [Next].

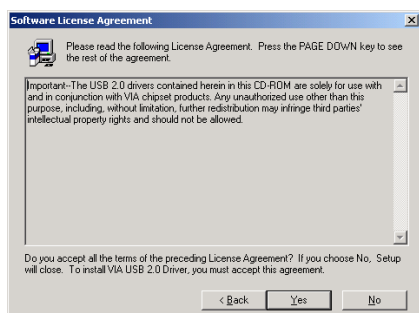

2. Click [Yes].

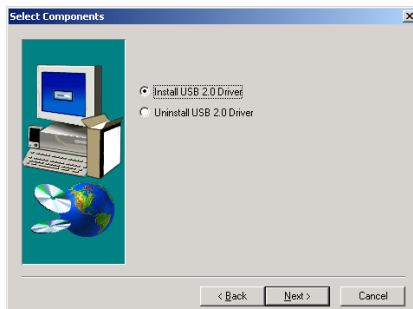

3. Click [Next].

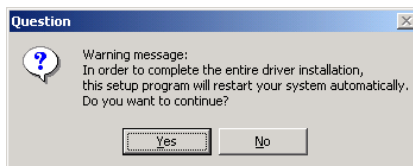

4. Click [Yes].

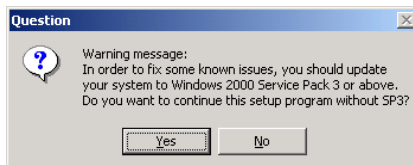

5. Click [Yes].

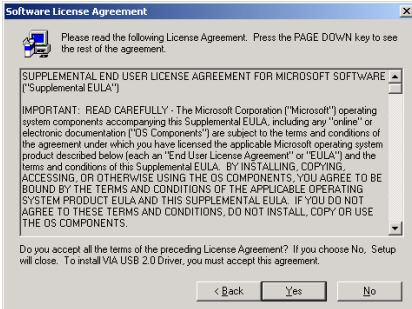

6. Click [Yes].

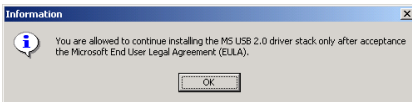

7. Click [OK].



8. Click [Print to File].

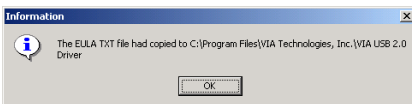

9. Click [OK].

Appendix E. Install VIA Serial ATA RAID Driver

The installation procedures and screen shots in this section are based on Windows XP operating system. For those of other OS, please follow its on-screen instruction.

Insert the Driver & Utility CD into CD-ROM drive, it should execute the installation program automatically. If not, double-click the execution file at the main directory of this CD to enter the installation menu.

After entering the installation menu, move your cursor to [Drivers] tab. Click [VIA SATA RAID Driver]. The following screen appears.

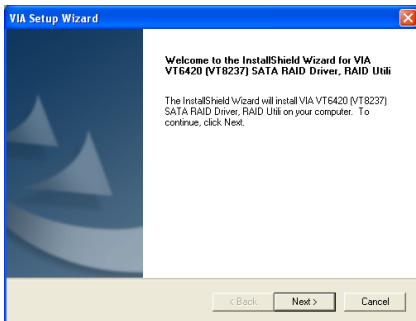

1. Click [Next].

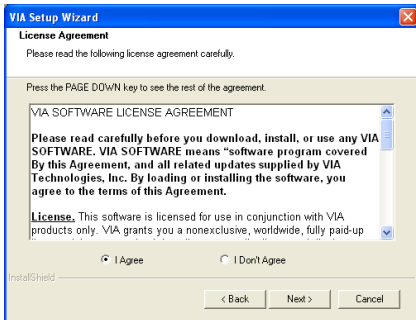

2. Click [Next].

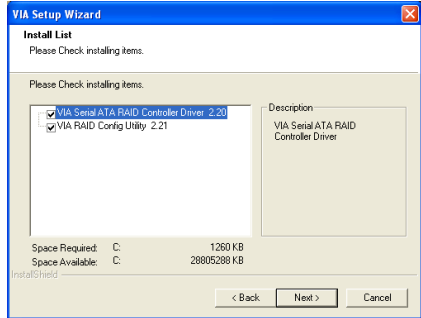

3. Click [Next].

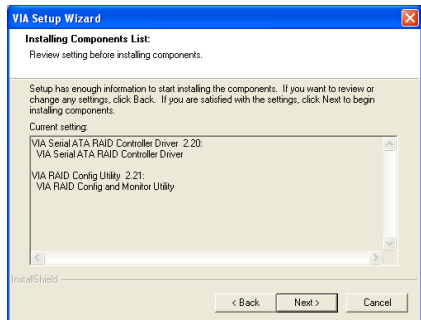

4. Click [Next].

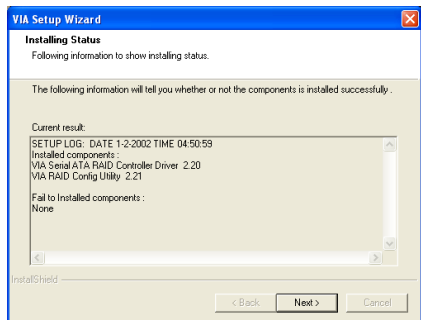

5. Click [Next].

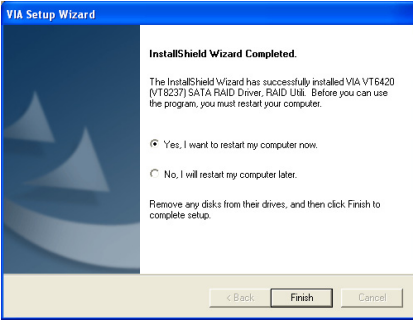

6. Choose [Yes, I want to restart my computer now.], and click [Finish] to complete setup.

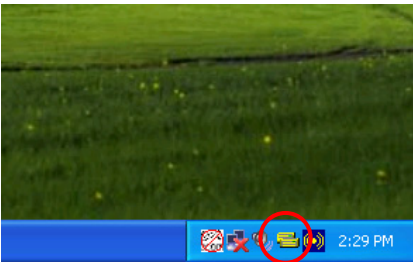

7. After the system restarted, a shortcut icon appears at the right corner of Windows task bar.

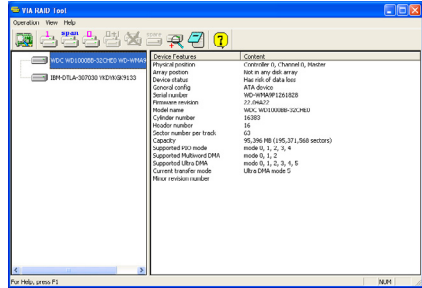

8. This is the “VIA RAID Tool” configuration menu. For more information on how to operate, please refer to the “Help” menu.

Appendix F. Install ABIT μ Guru Driver

ABIT μ Guru is a fresh Microprocessor developed by ABIT engineers used only on ABIT motherboards. This processor combines the current ABIT engineered features into a user-friendly Windows-based interface, providing users a perfect environment to maximize PC performance and stability.

To install the ABIT μ Guru driver, please insert the Driver & Utility CD into CD-ROM drive. It should execute the installation program automatically. If not, double-click the execution file at the main directory of this CD to enter the installation menu. The following screen appears.



Move your mouse to “ABIT Utility” tab. Click [ABIT μ Guru]. Follow the on-screen instruction to complete the driver installation.



Appendix G. POST Code Definition

AWARD POST Code Definition:

POST (hex)	Description
CF	Test CMOS R/W functionality
C0	Early chipset initialization: -Disable shadow RAM -Disable L2 cache (socket 7 or below) -Program basic chipset registers
C1	Detect memory -Auto-detection of DRAM size, type and ECC -Auto-detection of L2 cache (socket 7 or below)
C3	Expand compressed BIOS code to DRAM
C5	Call chipset hook to copy BIOS back to E000 & F000 shadow RAM
01	Expand the Xgroup codes locating in physical address 1000:0
03	Initial Superio_Early_Init switch
05	1. Blank out screen 2. Clear CMOS error flag
07	1. Clear 8042 interface 2. Initialize 8042 self-test
08	1. Test special keyboard controller for Winbond 977 series Super I/O chips 2. Enable keyboard interface
0A	1. Disable PS/2 mouse interface (optional) 2. Auto detect ports for keyboard & mouse followed by a port & interface swap (optional) 3. Reset keyboard for Winbond 977 series Super I/O chips
0E	Test F000h segment shadow to see whether it is R/W-able or not. If test fails, keep beeping the speaker
10	Auto detect flash type to load appropriate flash R/W codes into the run time area in F000 for ESCD & DMI support
12	Use walking 1's algorithm to check out interface in CMOS circuitry. Also set real-time clock power status, and then check for override
14	Program chipset default values into chipset. Chipset default values are MODBINable by OEM customers
16	Initial onboard clock generator if Early_Init_Onboard_Generator is defined. See also POST 26.
18	Detect CPU information including brand, SMI type (Cyrix or Intel) and CPU level (586 or 686)
1B	Initial interrupts vector table. If no special specified, all H/W interrupts are directed to SPURIOUS_INT_HDLR & S/W interrupts to SPURIOUS_soft_HDLR.
1D	Initial EARLY_PM_INIT switch

1F	Load keyboard matrix (notebook platform)
21	HPM initialization (notebook platform)
23	<ol style="list-style-type: none"> 1. Check validity of RTC value: e.g. a value of 5Ah is an invalid value for RTC minute. 2. Load CMOS settings into BIOS stack. If CMOS checksum fails, use default value instead.
24	Prepare BIOS resource map for PCI & PnP use. If ESCD is valid, take into consideration of the ESCD's legacy information.
25	<p>Early PCI Initialization:</p> <ul style="list-style-type: none"> -Enumerate PCI bus number. -Assign memory & I/O resource -Search for a valid VGA device & VGA BIOS, and put it into C000:0
26	<ol style="list-style-type: none"> 1. If Early_Init_Onboard_Generator is not defined Onboard clock generator initialization. Disable respective clock resource to empty PCI & DIMM slots. 2. Init onboard PWM 3. Init onboard H/W monitor devices
27	Initialize INT 09 buffer
29	<ol style="list-style-type: none"> 1. Program CPU internal MTRR (P6 & PII) for 0-640K memory address. 2. Initialize the APIC for Pentium class CPU. 3. Program early chipset according to CMOS setup. Example: onboard IDE controller. 4. Measure CPU speed.
2B	Invoke Video BIOS
2D	<ol style="list-style-type: none"> 1. Initialize double-byte language font (Optional) 2. Put information on screen display, including Award title, CPU type, CPU speed, full screen logo.
33	Reset keyboard if Early_Reset_KB is defined e.g. Winbond 977 series Super I/O chips. See also POST 63.
35	Test DMA Channel 0
37	Test DMA Channel 1.
39	Test DMA page registers.
3C	Test 8254
3E	Test 8259 interrupt mask bits for channel 1
40	Test 8259 interrupt mask bits for channel 2
43	Test 8259 functionality
47	Initialize EISA slot
49	<ol style="list-style-type: none"> 1. Calculate total memory by testing the last double word of each 64K page 2. Program writes allocation for AMD K5 CPU
4E	<ol style="list-style-type: none"> 1. Program MTRR of M1 CPU 2. Initialize L2 cache for P6 class CPU & program CPU with proper cacheable range 3. Initialize the APIC for P6 class CPU 4. On MP platform, adjust the cacheable range to smaller one in case the cacheable ranges between each CPU are not identical
50	Initialize USB
52	Test all memory (clear all extended memory to 0)
53	Clear password according to H/W jumper (Optional)

55	Display number of processors (multi-processor platform)
57	Display PnP logo Early ISA PnP initialization -Assign CSN to every ISA PnP device
59	Initialize the combined Trend Anti-Virus code
5B	(Optional Feature) Show message for entering AWDFLASH.EXE from FDD (optional)
5D	1. Initialize Init_Onboard_Super_IO 2. Initialize Init_Onboard_AUDIO
60	Okay to enter Setup utility; i.e. not until this POST stage can users enter the CMOS setup utility
63	Reset keyboard if Early_Reset_KB is not defined
65	Initialize PS/2 Mouse
67	Prepare memory size information for function call: INT 15h ax=E820h
69	Turn on L2 cache
6B	Program chipset registers according to items described in Setup & Auto-configuration table
6D	1. Assign resources to all ISA PnP devices 2. Auto assign ports to onboard COM ports if the corresponding item in Setup is set to "AUTO"
6F	1. Initialize floppy controller 2. Set up floppy related fields in 40:hardware
75	Detect & install all IDE devices: HDD, LS120, ZIP, CDROM ...
76	(Optional Feature) Enter AWDFLASH.EXE if: -AWDFLASH is found in floppy drive -ALT+F2 is pressed
77	Detect serial ports & parallel ports.
7A	Detect & install co-processor
7C	Init HDD write protect
7F	Switch back to text mode if full screen logo is supported -If errors occur, report errors & wait for keys -If no errors occur or F1 key is pressed to continue: Clear EPA or customization logo
E8POST.ASM starts	
82	1. Call chipset power management hook 2. Recover the text font used by EPA logo (not for full screen logo) 3. If password is set, ask for password
83	Save all data in stack back to CMOS
84	Initialize ISA PnP boot devices
85	1. USB final Initialization 2. Switch screen back to text mode
87	NET PC: Build SYSID Structure
89	1. Assign IRQs to PCI devices 2. Set up ACPI table at top of the memory.

8B	<ol style="list-style-type: none"> 1. Invoke all ISA adapter ROMs 2. Invoke all PCI ROMs (except VGA)
8D	<ol style="list-style-type: none"> 1. Enable/Disable Parity Check according to CMOS setup 2. APM Initialization
8F	Clear noise of IRQs
93	Read HDD boot sector information for Trend Anti-Virus code
94	<ol style="list-style-type: none"> 1. Enable L2 cache 2. Program Daylight Saving 3. Program boot up speed 4. Chipset final initialization. 5. Power management final initialization 6. Clear screen & display summary table 7. Program K6 write allocation 8. Program P6 class write combining
95	Update keyboard LED & typematic rate
96	<ol style="list-style-type: none"> 1. Build MP table 2. Build & update ESCD 3. Set CMOS century to 20h or 19h 4. Load CMOS time into DOS timer tick 5. Build MSIRQ routing table
FF	Boot attempt (INT 19h)

AC2003 POST Code Definition:

POST (hex)	Description
Power On Sequence	
8.1.	Start power on sequence
8.2.	Enable ATX power supply
8.3.	ATX power supply ready
8.4.	DDR voltage ready
8.5.	Setup PWM for CPU core voltage
8.6.	Assert PWM for CPU core voltage
8.7.	Check CPU core voltage
8.8.	CPU core voltage ready
8.9.	Initial clock generator IC
8.A.	North Bridge chipset voltage ready
8.B.	AGP voltage ready
8.C.	3VDUAL voltage ready
8.D.	VDDA 2.5V voltage ready
8.D.	GMCHVTT voltage ready
8.E.	Check CPU fan speed
8.F.	Assert all power ready
9.0.	Complete uGuru initial process AWARD BIOS take over booting job
Power Off Sequence	
9.1.	Start power off sequence
9.2.	De-Assert all power
9.3.	Se-Assert power on
9.4.	De-Assert LDT Bus power
9.5.	De-Assert PWM for CPU core voltage
9.6.	De-Assert CPU core voltage
9.7.	Check CPU core voltage
9.8.	De-Assert ATX power supply
9.9.	Complete power off sequence
Others	
F.0.	Button reset
F.1.	SoftMenu reset
F.2.	Power on sequence timeout
F.3.	Power off sequence timeout

NOTE: The decimal point lights up when executing the AC2003 POST action.



Appendix H. Troubleshooting (Need Assistance?)

Q & A:

Q: Do I need to clear the CMOS before I use a new motherboard to assemble my new computer system?

A: Yes, we highly recommend that you clear the CMOS before installing a new motherboard. Please move the CMOS jumper from its default 1-2 position to 2-3 for a few seconds, and then back. When you boot up your system for the first time, follow the instructions in the user's manual to load the optimized defaults.

Q: If my systems hang when I update the BIOS or set the wrong CPU parameters, what should I do?

A: Whenever you update the BIOS or if the system hangs due to wrong CPU parameters setting, always clear CMOS jumper before booting up again.

Q: Why the system failed to boot up and nothing was displayed on the screen after I did some over-clocking or non-standard settings inside the BIOS? Is the motherboard dead? Do I need to return it to where I bought from or go through an RMA process?

A: It should not cause hardware or permanent damage to motherboard when BIOS settings were changed from default to over-clocking or non-standard status.

We suggest the following three troubleshooting methods to discharge CMOS data, recover the hardware default status, and then make the motherboard working again. No need to bother returning the motherboard to where you bought from or go through an RMA process.

Step 1. Switch off the power supply unit and then switch it on again after one minute. If there is no power switch on the power supply unit, disconnect its power cord for one minute and then connect it back.

Press and hold the <Insert> key on the keyboard, press the power-on button to boot up system. If it works, loose the <Insert> key and hit key to enter the BIOS setup page to do the correct settings.

If the situation remains the same, repeat the procedures in Step 1 for three times, or try Step 2.

Step 2. Switch off the power supply unit or disconnect the power cord. Open the chassis cover. Locate the CCMOS jumper near the button battery. Change the jumper position from default 1-2 to 2-3 for one minute to discharge the CMOS data, and then put it back to default 1-2 position.

Close the chassis and switch on the power supply unit or plug in the power cord. Press the power-on button to boot up system. If it works, hit key to enter the BIOS setup page to do the correct settings.

If the situation remains the same, try Step 3.

Step 3. The same procedure as Step 2, but in the meantime of discharging the CMOS data, pull out ATX power connectors from motherboard and remove the button battery during CMOS discharging.

Q: How can I get a quick response to my request for technical support?

A: Be sure to follow the guidelines as stated in the “Technical Support Form” section of this manual.

If you have a problem during operation, in order to help our technical support personnel quickly determine the problem with your motherboard and give you the answers you need, before filling in the technical support form, eliminate any peripheral that is not related to the problem, and indicate it on the form. Fax this form to your dealer or to the company where you bought the hardware in order to benefit from our technical support. (You can refer to the examples given below)

Example 1:

With a system including: motherboard (with CPU, DRAM, COAST...) HDD, CD-ROM, FDD, VGA CARD, MPEG CARD, SCSI CARD, SOUND CARD, etc. After the system is assembled, if you cannot boot up, check the key components of the system using the procedure described below. First remove all interface cards except the VGA card and try to reboot.

If you still cannot boot up: Try installing another brand/model VGA card and see if the system will start. If it still does not start, note the VGA card model, motherboard model, Bios identification number, CPU on the technical support form (refer to main instructions), and describe the problem in the problem description space provided.

If you can boot up: Insert the interface cards you have removed back into the system, one by one and try to start the system each time you insert a card, until the system will not start. Keep the VGA card and the interface card that caused the problem inserted on the motherboard, remove any other cards or peripheral, and start again. If you still cannot start, note the information related to both cards in the add-on Card space provided, and don't forget to indicate the motherboard model, version, BIOS identification number, CPU (refer to main instructions), and give a description of the problem.

Example 2:

With a system including the motherboard (with CPU, DRAM, COAST...) HDD, CD-ROM, FDD, VGA CARD, LAN CARD, MPEG CARD, SCSI CARD, SOUND CARD, after assembly and after having installed the Sound Card Driver, when you restart the system, when it runs the Sound Card Driver, it resets automatically. This problem may be due to the Sound Card Driver. During the Starting DOS... procedure, press SHIFT (BY-PASS) key, to skip CONFIG.SYS and AUTOEXEC.BAT; edit CONFIG.SYS with a text editor, and in function the line that loads the Sound Card Driver, add a remark REM, in order to disable the Sound Card Driver. See the example below.

```
CONFIG.SYS:
DEVICE=C:\DOS\HIMEM.SYS
DEVICE=C:\DOS\EMM386.EXE HIGHSCAN
DOS=HIGH, UMB
FILES=40
BUFFERS=36
REM DEVICEHIGH=C:\PLUGPLAY\DWCFMG.MSYS
LASTDRIVE=Z
```

Restart the system. If the system starts and does not reset, you can be sure that the problem is due to the Sound Card Driver. Write down the Sound Card model, motherboard model, BIOS identification number on the technical support file (refer to main instructions), and describe the problem in the space provided.

We will show you how to fill the “Technical Support Form”.

Main instructions:

To fill in this “**Technical Support Form**”, refer to the step-by-step instructions given below:

- 1* **MODEL:** Note the model number given in your user’s manual.

Example: KV8 Pro

- 2* **Motherboard model number (REV):** Note the motherboard model number labeled on the motherboard as “REV:*.***”.

Example: REV: 1.01

- 3* **BIOS ID and Part Number:** See the on screen message.

4. **DRIVER REV:** Note the driver version number indicated on the DEVICE DRIVER disk (if any) as “Release *.*”. For example:

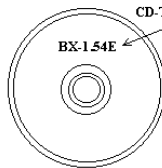

- 5* **OS/APPLICATION:** Indicate the operating system and applications you are running on the system.

Example: MS-DOS® 6.22, Windows® 98 SE, Windows® 2000, etc....

- 6* **CPU:** Indicate the brand and the speed (MHz) of your CPU.

Example:(A) In the “Brand” space, write “Intel”; in the “Specifications” space, write “Pentium® 4 1.9GHz”.

7. **HDD:** Indicate the brand and specifications of your HDD(s); specify if the HDD is using IDE1 or IDE2. If you know the disk capacity, indicate it and check (“✓”) “”; in case you give no indication, we will consider that your HDD is “IDE1” Master.

Example: In the “HDD” space, check the box; in the Brand space, write “Seagate”; in the Specifications space, write “ST31621A (1.6GB)”.

8. **CD-ROM Drive:** Indicate the brand and specifications of your CD-ROM drive. Specify if it uses IDE1 or IDE2 , and check (“✓”) “”; in case you give no indication, we will consider that your CD-ROM is “IDE2” Master.

Example: In the “CD-ROM drive” space, check the box, in the Brand space, write “Mitsumi”, in the Specifications space, write “FX-400D”.

9. **System Memory (DDR SDRAM):** Indicate the brand and specifications (DDR DIMM) of your system memory. Such as Density, Description, Module Components, Module Part Number, CAS Latency, and Speed (MHz).

For example: In the Brand space, write “**Micron**”; in the Specifications space, write: **Density:** 128MB, **Description:** SS 16 Megx72 2.5V ECC Gold, **Module Components:** (9) 16 Megx 8, **Module Part Number:** MT9VDDT1672AG, **CAS Latency:** 2, **Speed (MHz):** 200 MHz.

Please give us the detailed information of your DDR SDRAM module; it will help us to simulate the problems you met.

10. **ADD-ON CARD:** Indicate which add-on cards you are *absolutely sure* are related to the problem.

If you cannot identify the problem’s origin, indicate all the add-on cards inserted into your system.

NOTE: Items between the “*” are absolutely necessary.



Technical Support Form

Company Name:

Phone Number:

Contact Person:

Fax Number:

E-mail Address:

Model	*	BIOS ID #	*
Motherboard Model No.		DRIVER REV	
OS/Application	*		
Hardware Name	Brand	Specifications	
CPU	*		
HDD			
<input type="checkbox"/> IDE1 <input type="checkbox"/> IDE2			
CD-ROM-Drive			
<input type="checkbox"/> IDE1 <input type="checkbox"/> IDE2			
System Memory			
ADD-ON CARD			

Problem Description:



Appendix I. How to Get Technical Support

(From our website) <http://www.abit.com.tw>

(In North America) <http://www.abit-usa.com>

(In Europe) <http://www.abit.nl>

Thank you for choosing ABIT products. ABIT sells all our products through distributors, resellers and system integrators; we have no direct sales to end-users. Before sending email for tech support please check with your resellers or integrators if you need any services, they are the ones who sold you your system and they should know best as to what can be done, how they serve you is a good reference for future purchases.

We appreciate every customer and would like to provide the best service to you. Providing fast service to our customers is our top priority. However we receive many phone calls and a huge amount of email from all over the world. At the present time it is impossible for us to respond to every single inquiry. Therefore it is quite possible that if you send an email to us that you may not receive a response.

We have done many compatibility tests and reliability tests to make sure our products have the best quality and compatibility. In case you need service or technical support, please understand the constraint we have and **always check with the reseller who sold the product to you first.**

To expedite service, we recommend that you follow the procedures outlined below before contacting us. With your help, we can meet our commitment to provide the best service to the **greatest number of ABIT customers:**

- 1. Check the Manual.** It sounds simple but we have taken a lot of care in making a well-written and thorough manual. It is full of information that doesn't only pertain to motherboards. The CD-ROM included with your board will have the manual as well as drivers. If you don't have either one, go to our Program Download Area of the Website or FTP server.
- 2. Download latest BIOS, software or drivers.** Please go to our Program Download area on our Website to check to see if you have the latest BIOS. They are developed over periods of time to fix bugs or incompatibilities. **Also please make sure you have the latest drivers from your peripheral cards makers!**
- 3. Check the ABIT Technical Terms Guide and FAQ on our Website.** We are trying to expand and make the FAQs more helpful and information rich. Let us know if you have any suggestions. For hot topics, check out our HOT FAQ!

4. **Internet Newsgroups.** They are a great source of information and many people there can offer help. ABIT's Internet News group, alt.comp.periphs.mainboard.abit, is an ideal forum for the public to exchange information and discuss experiences they have had with ABIT products. Many times you will see that your question has already been asked before. This is a public Internet news group and it is reserved for free discussions. Here is a list of some of the more popular ones:

alt.comp.periphs.mainboard.abit
comp.sys.ibm.pc.hardware.chips
alt.comp.hardware.overclocking
alt.comp.hardware.homebuilt
alt.comp.hardware.pc-homebuilt

5. **Ask your reseller.** Your ABIT authorized distributor should be able to provide the fastest solution to your technical problem. We sell our products through distributors who sell to resellers and stores. Your reseller should be very familiar with your system configuration and should be able to solve your problem much more efficiently than we could. After all, your reseller regards you as an important customer who may purchase more products and who can urge your friends to buy from him or her as well. They integrated and sold the system to you. They should know best what your system configuration is and your problem. They should have reasonable return or refund policies. How they serve you is also a good reference for your next purchase.
6. **Contacting ABIT.** If you feel that you need to contact ABIT directly you can send email to the ABIT technical support department. First, please contact the support team for the branch office closest to you. They will be more familiar with local conditions and problems and will have better insight as to which resellers offer what products and services. Due to the huge number of emails coming in every day and other reasons, such as the time required for problem reproduction, we will not be able to reply to every email. Please understand that we are selling through distribution channels and don't have the resources to serve every end-user. However, we will try to do our best to help every customer. Please also remember that for many of our technical support team English is a second language, you will have a better chance of getting a helpful answer if your question can be understood in the first place. Be sure to use very, simple, concise language that clearly states the problem, avoid rambling or flowery language and always list your system components. Here is the contact information for our branch offices:

North America and South America:

ABIT Computer (U.S.A.) Corporation
45531 Northport Loop West,
Fremont, California 94538, U.S.A.
Tel: 1-510-623-0500
Fax: 1-510-623-1092
sales@abit-usa.com
technical@abit-usa.com
<http://www.abit-usa.com>

U.K. and Ireland:

ABIT Computer (U.K.) Corporation Ltd.
Unit 3, 24-26 Boulton Road,
Stevenage, Herts SG1 4QX, U.K.
Tel: 44-1438-228888
Fax: 44-1438-226333
sales@abitcomputer.co.uk
technical@abitcomputer.co.uk

Germany, Benelux (Belgium, Netherlands, Luxembourg), Denmark, Norway, Sweden, Finland, and Switzerland:

AMOR Computer B.V. (ABIT's European Office)
Van Coehoornstraat 7,
5916 PH Venlo, The Netherlands
Tel: 31-77-3204428
Fax: 31-77-3204420
sales@abit.nl
technical@abit.nl
<http://www.abit.nl>

Austria, Czech, Romania, Bulgaria, Yugoslavia, Slovakia, Slovenia, Croatia, Bosnia, Serbia, and Macedonia:

Asguard Computer Ges.m.b.H
Schmalbachstrasse 5,
A-2201 Gerasdorf/Wien, Austria
Tel: 43-1-7346709
Fax: 43-1-7346713
asguard@asguard.at

Japan:

ABIT Computer (Japan) Co. Ltd.
Fax: 81-3-5396-5110
<http://www.abit4u.jp>

Shanghai:

ABIT Computer (Shanghai) Co. Ltd.
Tel: 86-21-6235-1829
Fax: 86-21-6235-1832
<http://www.abit.com.cn>

Russia:

ABIT Computer (Russia) Co. Ltd.
Fax: 7-095-937-2837
techrussia@abit.com.tw
<http://www.abit.ru>

France, Italy, Spain, Portugal, and Greece:

ABIT Computer France SARL
Tel: 33-1-5858-0043
Fax: 33-1-5858-0047
<http://www.abit.fr>

All other territories not covered above please contact Taiwan Head Office:

When contacting our headquarters please Note we are located in Taiwan and we are 8+ GMT time. In addition, we have holidays that may be different from those in your country.

ABIT Computer Corporation
No.323, Yang Guang St., Neihu, Taipei, 114, Taiwan
Tel: 886-2-8751-8888
Fax: 886-2-8751-3382
sales@abit.com.tw
market@abit.com.tw
technical@abit.com.tw
<http://www.abit.com.tw>

7. **RMA Service.** If your system has been working but it just stopped, but you have not installed any new software or hardware recently, it is likely that you have a defective component. Please contact the reseller from whom you bought the product. You should be able to get RMA service there.
8. **Reporting Compatibility Problems to ABIT.** Because of tremendous number of email messages we receive every day, we are forced to give greater weight to certain types of messages than to others. For this reason, any compatibility problem that is reported to us, giving detailed system configuration information and error symptoms will receive the highest priority. For the other questions, we regret that we may not be able to reply directly. But your questions may be posted to the Internet news group in order that a larger number of users can have the benefit of the information. Please check the news group from time to time.
9. The information listed below are some **chipset vendors' WEB site addresses** for your reference:

HighPoint Technology Inc.'s WEB site: <http://www.highpoint-tech.com/>

Intel's WEB site: <http://www.intel.com/>

Silicon Image's WEB site: <http://www.siimage.com/>

SiS' WEB site: <http://www.sis.com.tw/>

VIA's WEB site: <http://www.via.com.tw/>

Thank You

ABIT Computer Corporation

<http://www.abit.com.tw>