

GA-M52L-S3

AM2 socket motherboard for
AMD Athlon™ 64 FX processor/
AMD Athlon™ 64 X2 Dual-Core processor/
AMD Athlon™ 64 processor/AMD Sempron™ processor

User's Manual

Rev. 2001

12ME-M52LS3-2001R

Declaration of Conformity

VE, Messungsinstrumente

G.B.T. Technology Trading GmbH
Bullenhöpel 16, 22047 Hamburg, Germany

declares that the product
(description of the apparatus, system, installation to which it refers)

Motherboard

GA-M52L-S3

is in conformity with the CE marking
(reference to the specification under which conformity is declared)
in accordance with 89/338 EEC-EMC Directive

- | | | | |
|---|--|---------------------------------------|--|
| <input type="checkbox"/> EN 55011 | Limits and methods of measurement of radio disturbance characteristics of industrial, scientific and medical (ISM) high frequency equipment | <input type="checkbox"/> EN 61000-3-2 | Disturbances in supply systems caused by equipment |
| <input type="checkbox"/> EN 55013 | Limits and methods of measurement of radio disturbance characteristics of broadcast receivers and associated equipment | <input type="checkbox"/> EN 61000-3-3 | Disturbances in supply systems caused by electrical equipment "Voltage fluctuations/flicker" |
| <input type="checkbox"/> EN 55014-1 | Limits and methods of measurement of radio disturbance characteristics of household electrical appliances, power tools and similar electrical appliances | <input type="checkbox"/> EN 55024 | Information Technology Equipment (ITE) Characteristics, Limits and methods of measurement |
| <input type="checkbox"/> EN 55015 | Limits and methods of measurement of radio disturbance characteristics of fluorescent lamps and luminaires | <input type="checkbox"/> EN 55025-1 | Generic Immunity standard Part 1: Residential, commercial and light industry |
| <input type="checkbox"/> EN 55020 | Immunity from radio interference of broadcast receivers and associated equipment | <input type="checkbox"/> EN 55025-2 | Generic Immunity standard Part 2: Industrial environment |
| <input type="checkbox"/> EN 55022 | Limits and methods of measurement of radio disturbance characteristics of information technology equipment | <input type="checkbox"/> EN 55014-2 | Immunity requirements for household appliances tools and similar apparatus |
| <input type="checkbox"/> DIN VDE 0885 part 10 | Cabled distribution systems, Equipment for receiving and/or distribution from sound and television signals | <input type="checkbox"/> EN 50991-2 | EMC requirements for uninterruptible power systems (UPS) |
| <input type="checkbox"/> EN 60935 | Safety requirements for mains operated electronic and related apparatus for household and similar general use | <input type="checkbox"/> EN 50991-1 | General and Safety requirements for uninterruptible power systems (UPS) |
| <input type="checkbox"/> EN 60335 | Safety of household and similar electrical appliances | | |



(CE conformity marking)

The manufacturer also declares the conformity of above mentioned product with the actual required safety standards in accordance with LVD 2006/95/EEC

Safety requirements for mains operated electronic and related apparatus for household and similar general use

Safety of household and similar electrical appliances

Safety for information technology equipment including electrical business equipment

General and Safety requirements for uninterruptible power systems (UPS)

Manufacturer/Importer

Signature: Timmy Huang

(Stamp)

Date: Aug. 2, 2007

Name: Timmy Huang

DECLARATION OF CONFORMITY

Per FCC Part 2, Section 2.1077(a)



Responsible Party Name: G.B.T. INC. (U.S.A.)

Address: 17358 Railroad Street

City of Industry, CA 91748

Phone/Fax No: (818) 854-9338/ (818) 854-9339

hereby declares that the product

Product Name: **Motherboard**

Model Number: GA-M52L-S3

Conforms to the following specifications:

FCC Part 15, Subpart B, Section 15.107(a) and Section 15.109

(a), Class B Digital Device

Supplementary Information:

This device complies with part 15 of the FCC Rules. Operation is subject to the following two conditions: (1) This device may not cause harmful and (2) this device must accept any interference received, including that may cause undesired operation.

Representative Person's Name: ERIC LIU

Signature: Eric Liu

Date: Aug. 2, 2007

Copyright

© 2008 GIGA-BYTE TECHNOLOGY CO., LTD. All rights reserved.

The trademarks mentioned in this manual are legally registered to their respective owners.

The **GIGABYTE** logo is exclusively licensed to GIGABYTE UNITED INC. by GIGA-BYTE TECHNOLOGY CO., LTD.

GIGABYTE UNITED INC. is designated by GIGA-BYTE TECHNOLOGY CO., LTD as the exclusive global distributor of GIGABYTE branded motherboards.

Disclaimer

Information in this manual is protected by copyright laws and is the property of GIGABYTE.

Changes to the specifications and features in this manual may be made by GIGABYTE without prior notice. No part of this manual may be reproduced, copied, translated, transmitted, or published in any form or by any means without GIGABYTE's prior written permission.

Documentation Classifications

In order to assist in the use of this product, GIGABYTE provides the following types of documentations:

- For quick set-up of the product, read the Quick Installation Guide included with the product.
- For detailed product information, carefully read the User's Manual.
- For instructions on how to use GIGABYTE's unique features, read or download the information on/from the Support\Motherboard\Technology Guide page on our website.

For product-related information, check on our website at:

<http://www.gigabyte.com.tw>

Identifying Your Motherboard Revision

The revision number on your motherboard looks like this: "REV: X.X." For example, "REV: 1.0" means the revision of the motherboard is 1.0. Check your motherboard revision before updating motherboard BIOS, drivers, or when looking for technical information.

Example:

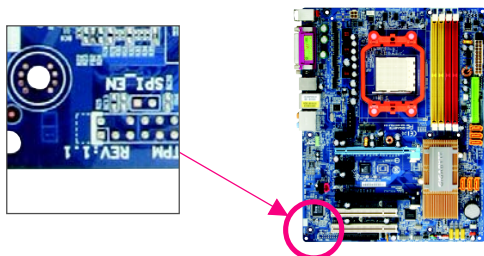

Table of Contents

Box Contents	6
Optional Items	6
GA-M52L-S3 Motherboard Layout	7
Block Diagram	8
Chapter 1 Hardware Installation	9
1-1 Installation Precautions	9
1-2 Product Specifications	10
1-3 Installing the CPU and CPU Cooler	12
1-3-1 Installing the CPU	12
1-3-2 Installing the CPU Cooler	14
1-4 Installing the Memory	15
1-4-1 Dual Channel Memory Configuration	15
1-4-2 Installing a Memory	16
1-5 Installing an Expansion Card	17
1-6 Back Panel Connectors	18
1-7 Internal Connectors	20
Chapter 2 BIOS Setup	31
2-1 Startup Screen	32
2-2 The Main Menu	33
2-3 Standard CMOS Features	35
2-4 Advanced BIOS Features	37
2-5 Integrated Peripherals	39
2-6 Power Management Setup	42
2-7 PnP/PCI Configurations	44
2-8 PC Health Status	45
2-9 MB Intelligent Tweaker(M.I.T.)	47
2-10 Load Fail-Safe Defaults	49
2-11 Load Optimized Defaults	49
2-12 Set Supervisor/User Password	50
2-13 Save & Exit Setup	51
2-14 Exit Without Saving	51

Chapter 3 Drivers Installation	53
3-1 Installing Chipset Drivers	53
3-2 Software Applications	54
3-3 Driver CD Information	54
3-4 Hardware Information	55
3-5 Contact Us	55
 Chapter 4 Unique Features	 57
4-1 Xpress Recovery2	57
4-2 BIOS Update Utilities	62
4-2-1 Updating the BIOS with the Q-Flash Utility	62
4-2-2 Updating the BIOS with the @BIOS Utility	65
4-3 EasyTune 5	67
4-4 Windows Vista ReadyBoost	68
 Chapter 5 Appendix	 69
5-1 Configuring SATA Hard Drive(s)	69
5-1-1 Configuring the Onboard SATA Controller	69
5-1-2 Making a SATA RAID Driver Diskette (For Windows XP and 2000)	74
5-1-3 Installing the SATA RAID Driver and Operating System	75
5-2 Configuring Audio Input and Output	78
5-2-1 Configuring 2/4/5.1/7.1-Channel Audio	78
5-2-2 Installing the S/PDIF In Cable (Optional)	80
5-2-3 Configuring Microphone Recording	82
5-2-4 Using the Sound Recorder	84
5-3 Troubleshooting	85
5-3-1 Frequently Asked Questions	85
5-3-2 Troubleshooting Procedure	86
 Regulatory Statements	 88

Box Contents

- GA-M52L-S3 motherboard
- Motherboard driver disk
- Motherboard driver disk (For Windows Vista)
- User's Manual
- Quick Installation Guide
- One IDE cable and one floppy disk drive cable
- One SATA 3Gb/s cable
- I/O Shield

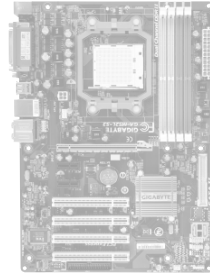

- The box contents above are for reference only and the actual items shall depend on product package you obtain. The box contents are subject to change without notice.
- The motherboard image is for reference only.

Optional Items

- 2-port USB 2.0 bracket (Part No. 12CR1-1UB030-51R)
- 2-port SATA power cable (Part No. 12CF1-2SERPW-01R)
- S/PDIF in cable (Part No. 12CR1-1SPDIN-01R)

GA-M52L-S3 Motherboard Layout

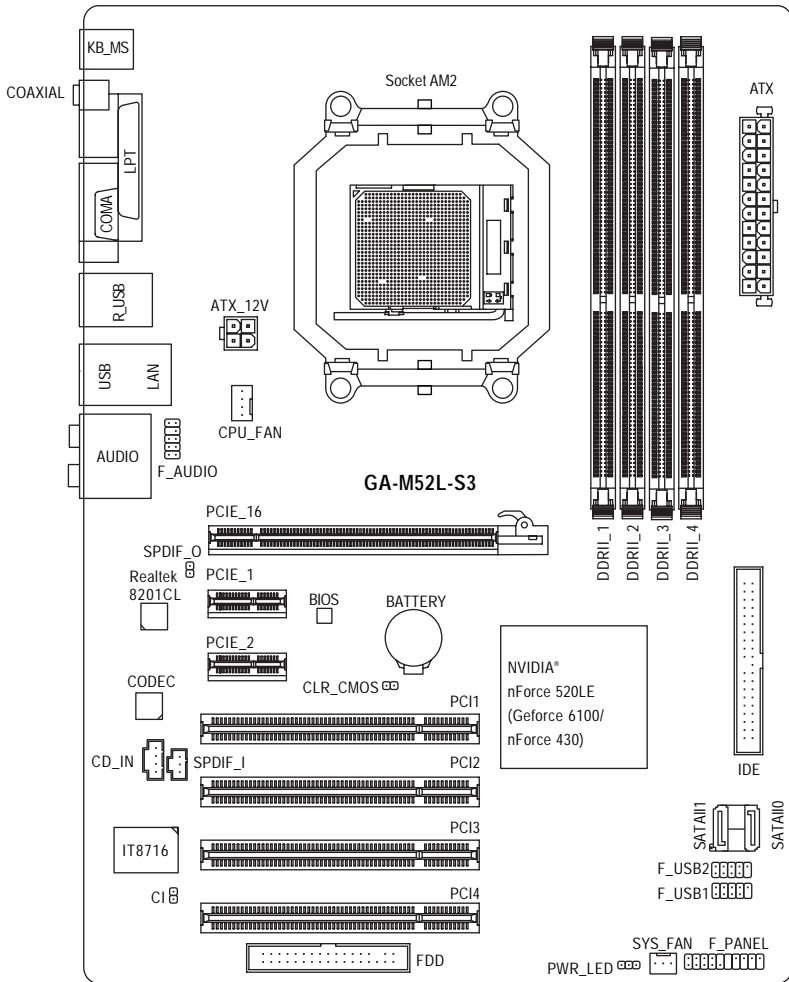

Block Diagram

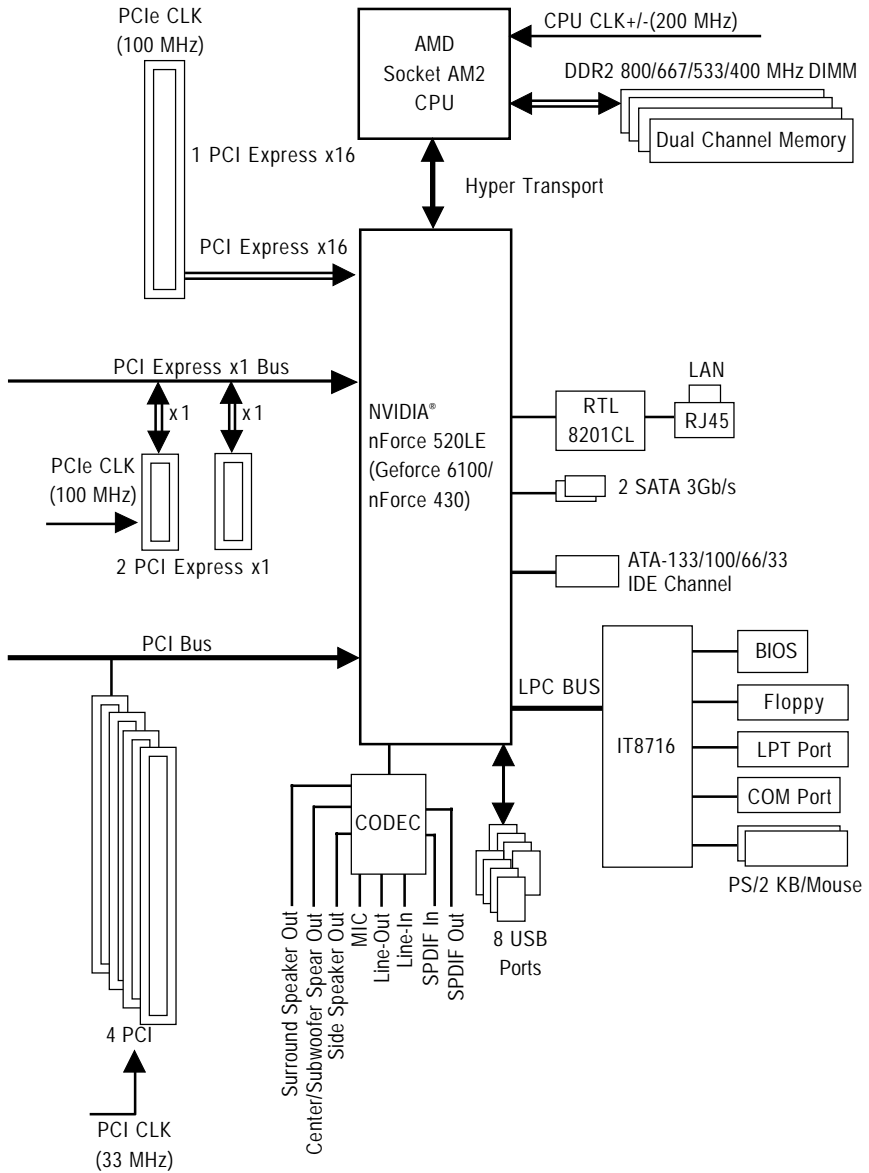

Chapter 1 Hardware Installation

1-1 Installation Precautions

The motherboard contains numerous delicate electronic circuits and components which can become damaged as a result of electrostatic discharge (ESD). Prior to installation, carefully read the user's manual and follow these procedures:

- Prior to installation, do not remove or break motherboard S/N (Serial Number) sticker or warranty sticker provided by your dealer. These stickers are required for warranty validation.
- Always remove the AC power by unplugging the power cord from the power outlet before installing or removing the motherboard or other hardware components.
- When connecting hardware components to the internal connectors on the motherboard, make sure they are connected tightly and securely.
- When handling the motherboard, avoid touching any metal leads or connectors.
- It is best to wear an electrostatic discharge (ESD) wrist strap when handling electronic components such as a motherboard, CPU or memory. If you do not have an ESD wrist strap, keep your hands dry and first touch a metal object to eliminate static electricity.
- Prior to installing the motherboard, please have it on top of an antistatic pad or within an electrostatic shielding container.
- Before unplugging the power supply cable from the motherboard, make sure the power supply has been turned off.
- Before turning on the power, make sure the power supply voltage has been set according to the local voltage standard.
- Before using the product, please verify that all cables and power connectors of your hardware components are connected.
- To prevent damage to the motherboard, do not allow screws to come in contact with the motherboard circuit or its components.
- Make sure there are no leftover screws or metal components placed on the motherboard or within the computer casing.
- Do not place the computer system on an uneven surface.
- Do not place the computer system in a high-temperature environment.
- Turning on the computer power during the installation process can lead to damage to system components as well as physical harm to the user.
- If you are uncertain about any installation steps or have a problem related to the use of the product, please consult a certified computer technician.

1-2 Product Specifications

CPU	<ul style="list-style-type: none"> Support for Socket AM2 processors: AMD Athlon™ 64 FX processor/AMD Athlon™ 64 X2 Dual-Core processor/ AMD Athlon™ 64 processor/AMD Sempron™ processor (Go to GIGABYTE's website for the latest CPU support list.)
Hyper Transport Bus	<ul style="list-style-type: none"> 2000 MT/s
Chipset	<ul style="list-style-type: none"> NVIDIA® nForce 520LE(Geforce 6100/nForce 430) chipset
Memory	<ul style="list-style-type: none"> 4 x 1.8V DDR2 DIMM sockets supporting up to 16 GB of system memory ^(Note 1) Dual channel memory architecture Support for DDR2 800/667/533/400 MHz memory modules (Go to GIGABYTE's website for the latest memory support list.)
Audio	<ul style="list-style-type: none"> Realtek ALC883 codec High Definition Audio 2/4/5.1/7.1-channel Support for S/PDIF In/Out Support for CD In
LAN	<ul style="list-style-type: none"> RTL 8201CL chip (10/100 Mbit)
Expansion Slots	<ul style="list-style-type: none"> 1 x PCI Express x16 slot 2 x PCI Express x1 slots 4 x PCI slots
Storage Interface	<ul style="list-style-type: none"> NVIDIA® nForce 520LE(Geforce 6100/nForce 430) chipset: <ul style="list-style-type: none"> 1 x IDE connector supporting ATA-133/100/66/33 and up to 2 IDE devices 2 x SATA 3Gb/s connectors supporting up to 2 SATA 3Gb/s devices Support for SATA RAID 0 and RAID 1 ITE IT8716 chip: <ul style="list-style-type: none"> 1 x floppy disk drive connector supporting up to 1 floppy disk drive
USB	<ul style="list-style-type: none"> Integrated in the NVIDIA® nForce 520LE(Geforce 6100/nForce 430) chipset Up to 8 USB 2.0/1.1 ports (4 on the back panel, 4 via the USB brackets connected to the internal USB headers)
Internal Connectors	<ul style="list-style-type: none"> 1 x 24-pin ATX main power connector 1 x 4-pin ATX 12V power connector 1 x floppy disk drive connector 1 x IDE connector 2 x SATA 3Gb/s connectors 1 x CPU fan header 1 x system fan header 1 x front panel header 1 x front panel audio header 1 x CD In connector 1 x S/PDIF In header 1 x S/PDIF Out header 2 x USB 2.0/1.1 headers 1 x chassis intrusion header 1 x power LED header

Back Panel Connectors	<ul style="list-style-type: none"> ◆ 1 x PS/2 keyboard port ◆ 1 x PS/2 mouse port ◆ 1 x parallel port ◆ 1 x coaxial S/PDIF Out connector ◆ 1 x COMA port ◆ 4 x USB 2.0/1.1 ports ◆ 1 x RJ-45 port ◆ 6 x audio jacks (Center/Subwoofer Speaker Out/Rear Speaker Out/Side Speaker Out/Line In/Line Out/Microphone)
I/O Controller	<ul style="list-style-type: none"> ◆ iTE IT8716 chip
Hardware Monitor	<ul style="list-style-type: none"> ◆ System voltage detection ◆ CPU/System temperature detection ◆ CPU/System fan speed detection ◆ CPU/System overheating warning ◆ CPU/System fan fail warning ◆ CPU/System fan speed control ^(Note 2)
BIOS	<ul style="list-style-type: none"> ◆ 1 x 4 Mbit flash ◆ Use of licensed AWARD BIOS ◆ PnP 1.0a, DMI 2.0, SM BIOS 2.4, ACPI 1.0b
Unique Features	<ul style="list-style-type: none"> ◆ Support for @BIOS ◆ Support for Download Center ◆ Support for Q-Flash ◆ Support for EasyTune ^(Note 3) ◆ Support for Xpress Install ◆ Support for Xpress Recovery2 ◆ Support for Virtual Dual BIOS
Bundled Software	<ul style="list-style-type: none"> ◆ Norton Internet Security (OEM version)
Operating System	<ul style="list-style-type: none"> ◆ Support for Microsoft® Windows® Vista/XP/2000
Form Factor	<ul style="list-style-type: none"> ◆ ATX form factor; 30.5cm x 21.5cm

(Note 1) Due to Windows XP 32-bit operating system limitation, when more than 4 GB of physical memory is installed, the actual memory size displayed will be less than 4 GB.

(Note 2) Whether the CPU fan speed control function is supported will depend on the CPU you install.

(Note 3) Available functions in EasyTune may differ by motherboard model.

1-3 Installing the CPU and CPU Cooler



Read the following guidelines before you begin to install the CPU:

- Make sure that the motherboard supports the CPU.
(Go to GIGABYTE's website for the latest CPU support list.)
- Always turn off the computer and unplug the power cord from the power outlet before installing the CPU to prevent hardware damage.
- Locate the pin one of the CPU. The CPU cannot be inserted if oriented incorrectly.
- Apply an even and thin layer of thermal grease on the surface of the CPU.
- Do not turn on the computer if the CPU cooler is not installed, otherwise overheating and damage of the CPU may occur.
- Set the CPU host frequency in accordance with the CPU specifications. It is not recommended that the system bus frequency be set beyond hardware specifications since it does not meet the standard requirements for the peripherals. If you wish to set the frequency beyond the standard specifications, please do so according to your hardware specifications including the CPU, graphics card, memory, hard drive, etc.

1-3-1 Installing the CPU

- A. Locate the pin one (denoted by a small triangle) of the CPU socket and the CPU.

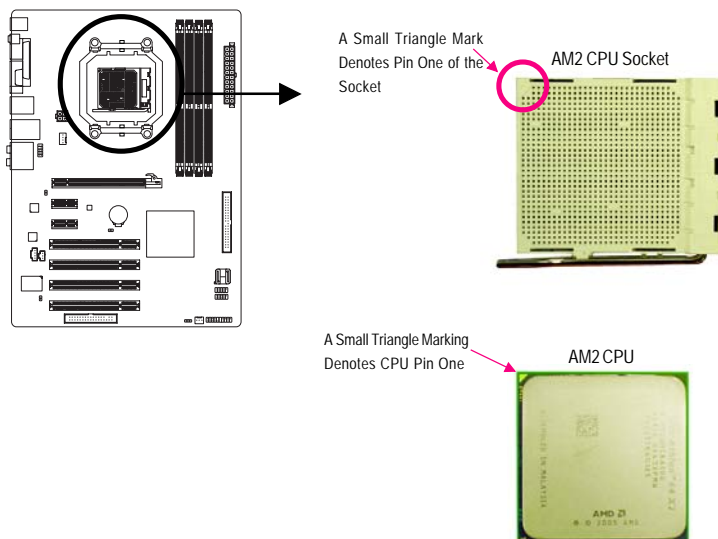

B. Follow the steps below to correctly install the CPU into the motherboard CPU socket.



Before installing the CPU, make sure to turn off the computer and unplug the power cord from the power outlet to prevent damage to the CPU.

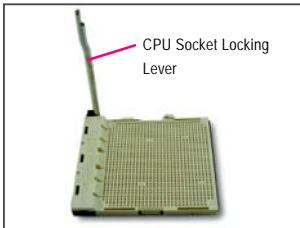

Step 1:
Completely lift up the CPU socket locking lever.



Step 2:
Align the CPU pin one (small triangle marking) with the triangle mark on the CPU socket and gently insert the CPU into the socket. Make sure that the CPU pins fit perfectly into their holes. Once the CPU is positioned into its socket, place one finger down on the middle of the CPU, lowering the locking lever and latching it into the fully locked position.



Do not force the CPU into the CPU socket. The CPU cannot fit in if oriented incorrectly. Adjust the CPU orientation if this occurs.

1-3-2 Installing the CPU Cooler

Follow the steps below to correctly install the CPU cooler on the CPU. (The following procedure uses the GIGABYTE cooler as the example.)

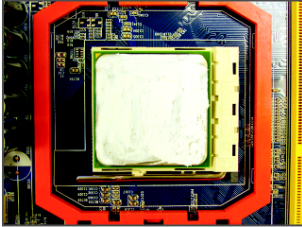

Step 1:
Apply an even and thin layer of thermal grease on the surface of the installed CPU.

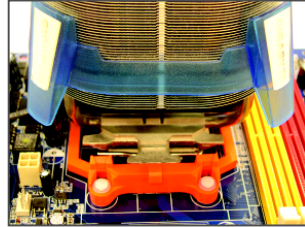

Step 2:
Place the CPU cooler on the CPU.



Step 3:
Hook the CPU cooler clip to the mounting lug on one side of the retention frame. On the other side, push straight down on the CPU cooler clip to hook it to the mounting lug on the retention frame.

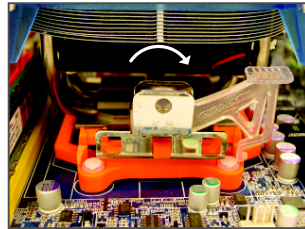

Step 4:
Turn the cam handle from the left side to the right side (as the picture above shows) to lock into place. (Refer to your CPU cooler installation manual for instructions on installing the cooler.)

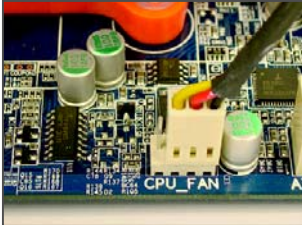

Step 5:
Finally, attach the power connector of the CPU cooler to the CPU fan header (CPU_FAN) on the motherboard.



Use extreme care when removing the CPU cooler because the thermal grease/tape between the CPU cooler and CPU may adhere to the CPU. Inadequately removing the CPU cooler may damage the CPU.

1-4 Installing the Memory



Read the following guidelines before you begin to install the memory:

- Make sure that the motherboard supports the memory. It is recommended that memory of the same capacity, brand, speed, and chips be used. (Go to GIGABYTE's website for the latest memory support list.)
- Always turn off the computer and unplug the power cord from the power outlet before installing the memory to prevent hardware damage.
- Memory modules have a foolproof design. A memory module can be installed in only one direction. If you are unable to insert the memory, switch the direction.

1-4-1 Dual Channel Memory Configuration



This motherboard provides four DDR2 memory sockets and supports Dual Channel Technology. After the memory is installed, the BIOS will automatically detect the specifications and capacity of the memory. Enabling Dual Channel memory mode will double the original memory bandwidth.

The four DDR2 memory sockets are divided into two channels and each channel has two memory sockets as following:

- ▶ Channel 0: DDRII_1, DDRII_3
- ▶ Channel 1: DDRII_2, DDRII_4

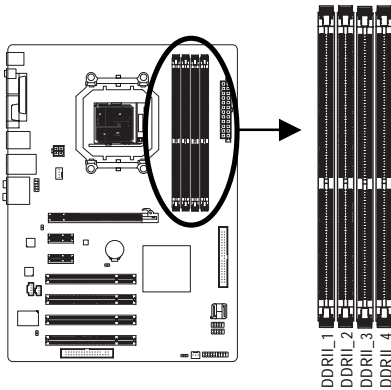

▶ Dual Channel Memory Configurations Table

	DDRII_1	DDRII_2	DDRII_3	DDRII_4
Two Modules	DS/SS	DS/SS	--	--
	--	--	DS/SS	DS/SS
Four Modules	DS/SS	DS/SS	DS/SS	DS/SS

(SS=Single-Sided, DS=Double-Sided, "--=No Memory)



NOTE If two memory modules are to be installed, it is recommended that you install them in the DDRII_1 and DDRII_2 sockets.

Due to CPU limitation, read the following guidelines before installing the memory in Dual Channel mode.

1. Dual Channel mode cannot be enabled if only one DDR2 memory module is installed.
2. When enabling Dual Channel mode with two or four memory modules, it is recommended that memory of the same capacity, brand, speed, and chips be used and installed in the same colored DDR2 sockets for optimum performance.

1-4-2 Installing a Memory



Before installing a memory module, make sure to turn off the computer and unplug the power cord from the power outlet to prevent damage to the memory module. DDR2 DIMMs are not compatible to DDR DIMMs. Be sure to install DDR2 DIMMs on this motherboard.

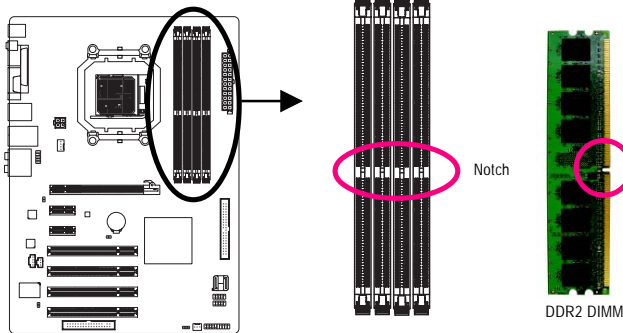

A DDR2 memory module has a notch, so it can only fit in one direction. Follow the steps below to correctly install your memory modules in the memory sockets.

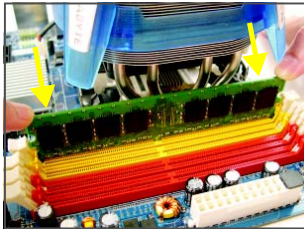

Step 1:

Note the orientation of the memory module. Spread the retaining clips at both ends of the memory socket. Place the memory module on the socket. As indicated in the picture on the left, place your fingers on the top edge of the memory, push down on the memory and insert it vertically into the memory socket.

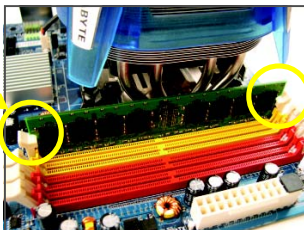

Step 2:

The clips at both ends of the socket will snap into place when the memory module is securely inserted.

1-5 Installing an Expansion Card



Read the following guidelines before you begin to install an expansion card:

- Make sure the motherboard supports the expansion card. Carefully read the manual that came with your expansion card.
- Always turn off the computer and unplug the power cord from the power outlet before installing an expansion card to prevent hardware damage.

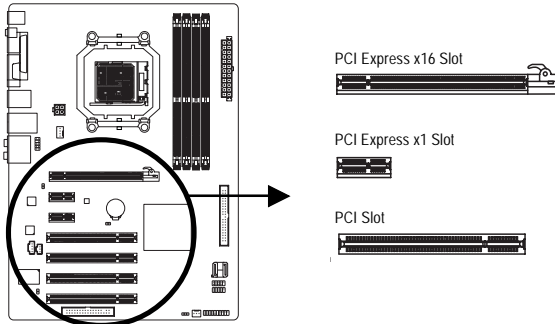

Follow the steps below to correctly install your expansion card in the expansion slot.

1. Locate an expansion slot that supports your card. Remove the metal slot cover from the chassis back panel.
2. Align the card with the slot, and press down on the card until it is fully seated in the slot.
3. Make sure the metal contacts on the card are completely inserted into the slot.
4. Secure the card's metal bracket to the chassis back panel with a screw.
5. After installing all expansion cards, replace the chassis cover(s).
6. Turn on your computer. If necessary, go to BIOS Setup to make any required BIOS changes for your expansion card(s).
7. Install the driver provided with the expansion card in your operating system.

Example: Installing and Removing a PCI Express x16 Graphics Card:



- **Installing a Graphics Card:**
Gently insert the graphics card into the PCI Express x16 slot. Make sure the graphics card is locked by the latch at the end of the PCI Express x16 slot.



- **Removing the Card:**
Press the white latch at the end of the PCI Express x16 slot to release the card and then pull the card straight up from the slot.

1-6 Back Panel Connectors

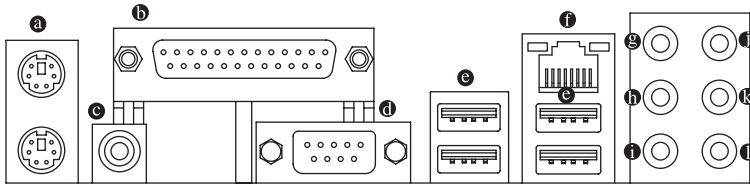

a PS/2 Keyboard and PS/2 Mouse Port

Use the upper port (green) to connect a PS/2 mouse and the lower port (purple) to connect a PS/2 keyboard.

b Parallel Port

Use the parallel port to connect devices such as a printer, scanner and etc. The parallel port is also called a printer port.

c Coaxial S/PDIF Out Connector

This connector provides digital audio out to an external audio system that supports digital coaxial audio. Before using this feature, ensure that your audio system provides a coaxial digital audio in connector.

d Serial Port

Use the serial port to connect devices such as a mouse, modem or other peripherals.

e USB Port

The USB port supports the USB 2.0/1.1 specification. Use this port for USB devices such as an USB keyboard/mouse, USB printer, USB flash drive and etc.

f RJ-45 LAN Port

The Fast Ethernet LAN port provides Internet connection at up to 100 Mbps data rate. The following describes the states of the LAN port LEDs.

Connection/
Speed LED

Activity LED



LAN Port

Connection/Speed LED:

State	Description
Green	100 Mbps data rate
Off	10 Mbps data rate

Activity LED:

State	Description
Blinking	Data transmission or receiving is occurring
Off	No data transmission or receiving is occurring



- When removing the cable connected to a back panel connector, first remove the cable from your device and then remove it from the motherboard.
- When removing the cable, pull it straight out from the connector. Do not rock it side to side to prevent an electrical short inside the cable connector.

- ④ **Center/Subwoofer Speaker Out Jack (Orange)**
Use this audio jack to connect center/subwoofer speakers in a 5.1/7.1-channel audio configuration.
- ④ **Rear Speaker Out Jack (Black)**
Use this audio jack to connect rear speakers in a 4/5.1/7.1-channel audio configuration.
- ④ **Side Speaker Out Jack (Gray)**
Use this audio jack to connect side speakers in a 7.1-channel audio configuration.
- ④ **Line In Jack (Blue)**
The default line in jack. Use this audio jack for line in devices such as an optical drive, walkman, etc.
- ④ **Line Out Jack (Green)**
The default line out jack. Use this audio jack for a headphone or 2-channel speaker. This jack can be used to connect front speakers in a 4/5.1/7.1-channel audio configuration.
- ④ **Mic In Jack (Pink)**
The default Mic in jack. Microphones must be connected to this jack.



In addition to the default speakers settings, the ④ - ④ audio jacks can be reconfigured to perform different functions via the audio software. Only microphones still **MUST** be connected to the default Mic in jack (④). Refer to the instructions on setting up a 2/4/5.1/7.1-channel audio configuration in Chapter 5, "Configuring 2/4/5.1/7.1-Channel Audio."

1-7 Internal Connectors

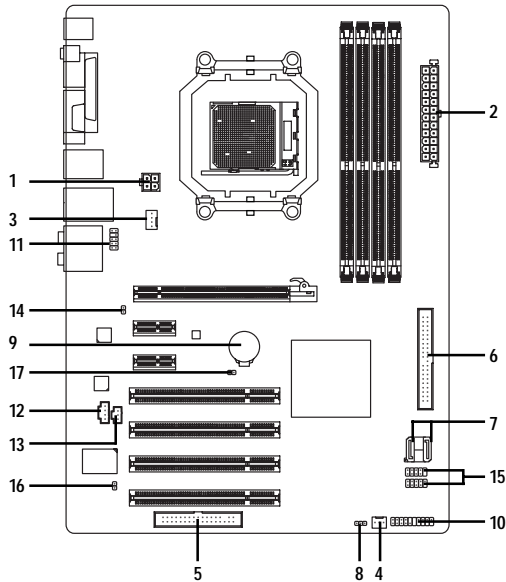

1)	ATX_12V	10)	F_PANEL
2)	ATX	11)	F_AUDIO
3)	CPU_FAN	12)	CD_IN
4)	SYS_FAN	13)	SPDIF_I
5)	FDD	14)	SPDIF_O
6)	IDE	15)	F_USB1 / F_USB2
7)	SATAII0 / 1	16)	CI
8)	PWR_LED	17)	CLR_CMOS
9)	BATTERY		



Read the following guidelines before connecting external devices:

- First make sure your devices are compliant with the connectors you wish to connect.
- Before installing the devices, be sure to turn off the devices and your computer. Unplug the power cord from the power outlet to prevent damage to the devices.
- After installing the device and before turning on the computer, make sure the device cable has been securely attached to the connector on the motherboard.

1/2) ATX_12V/ATX (2x2 12V Power Connector and 2x12 Main Power Connector)

With the use of the power connector, the power supply can supply enough stable power to all the components on the motherboard. Before connecting the power connector, first make sure the power supply is turned off and all devices are properly installed. The power connector possesses a foolproof design. Connect the power supply cable to the power connector in the correct orientation. The 12V power connector mainly supplies power to the CPU. If the 12V power connector is not connected, the computer will not start.



- To meet expansion requirements, it is recommended that a power supply that can withstand high power consumption be used (400W or greater). If a power supply is used that does not provide the required power, the result can lead to an unstable or unbootable system.
- The main power connector is compatible with power supplies with 2x10 power connectors. When using a 2x12 power supply, remove the protective cover from the main power connector on the motherboard. Do not insert the power supply cable into pins under the protective cover when using a 2x10 power supply.

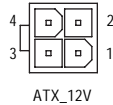
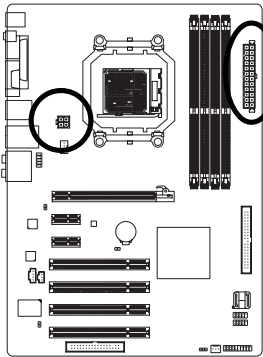

ATX_12V:

Pin No.	Definition
1	GND
2	GND
3	+12V
4	+12V

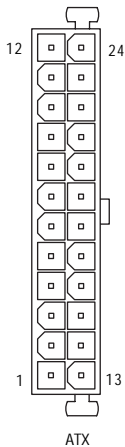

ATX:

Pin No.	Definition	Pin No.	Definition
1	3.3V	13	3.3V
2	3.3V	14	-12V
3	GND	15	GND
4	+5V	16	PS_ON(soft On/Off)
5	GND	17	GND
6	+5V	18	GND
7	GND	19	GND
8	Power Good	20	-5V
9	5V SB(stand by +5V)	21	+5V
10	+12V	22	+5V
11	+12V (Only for 2x12-pin ATX)	23	+5V (Only for 2x12-pin ATX)
12	3.3V (Only for 2x12-pin ATX)	24	GND (Only for 2x12-pin ATX)

3/4) CPU_FAN/SYS_FAN (Fan Headers)

The motherboard has a 4-pin CPU fan header (CPU_FAN) and a 3-pin system fan header (SYS_FAN). Each fan header supplies a +12V power voltage and possesses a foolproof insertion design. When connecting a fan cable, be sure to connect it in the correct orientation. Most fans are designed with color-coded power connector wires. A red power connector wire indicates a positive connection and requires a +12V voltage. The black connector wire is the ground wire. The motherboard supports CPU fan speed control, which requires the use of a CPU fan with fan speed control design. For optimum heat dissipation, it is recommended that a system fan be installed inside the chassis.

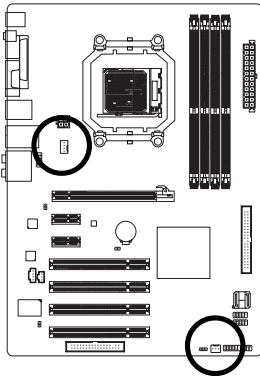

CPU_FAN:

Pin No.	Definition
1	GND
2	+12V / Speed Control
3	Sense
4	Speed Control



SYS_FAN:

Pin No.	Definition
1	GND
2	+12V
3	Sense



- Be sure to connect fan cables to the fan headers to prevent your CPU and system from overheating. Overheating may result in damage to the CPU or the system may hang.
- These fan headers are not configuration jumper blocks. Do not place a jumper cap on the headers.

5) FDD (Floppy Disk Drive Connector)

This connector is used to connect a floppy disk drive. The types of floppy disk drives supported are: 360 KB, 720 KB, 1.2 MB, 1.44 MB, and 2.88 MB. Before connecting a floppy disk drive, be sure to locate pin 1 of the connector and the floppy disk drive cable. The pin 1 of the cable is typically designated by a stripe of different color.

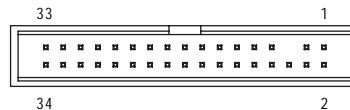
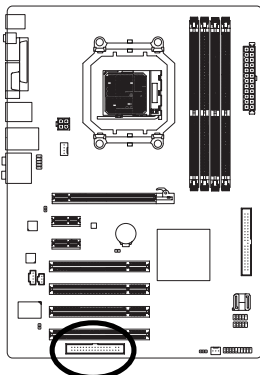

6) IDE (IDE Connector)

The IDE connector supports up to two IDE devices such as hard drives and optical drives. Before attaching the IDE cable, locate the foolproof groove on the connector. If you wish to connect two IDE devices, remember to set the jumpers and the cabling according to the role of the IDE devices (for example, master or slave). (For information about configuring master/slave settings for the IDE devices, read the instructions from the device manufacturers.)

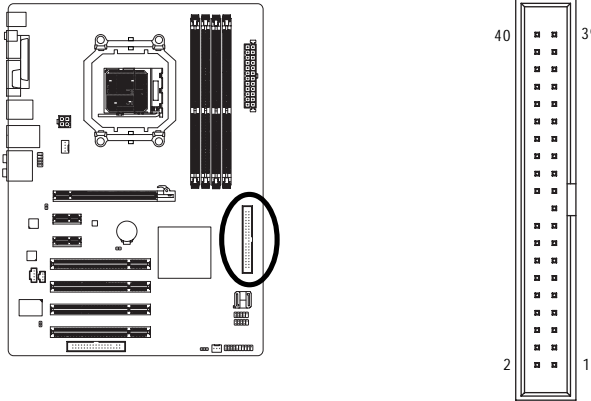

7) SATAII0/1 (SATA 3Gb/s Connectors)

The SATA connectors conform to SATA 3Gb/s standard and are compatible with SATA 1.5Gb/s standard. Each SATA connector supports a single SATA device. The NVIDIA® nForce 520LE (Geforce 6100/nForce 430) controller supports RAID 0 and RAID 1. Refer to Chapter 5, "Configuring SATA Hard Drive(s)," for instructions on configuring a RAID array.

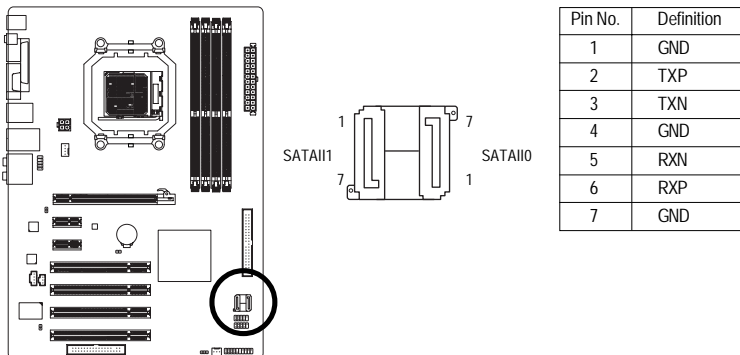

A RAID 0 or RAID 1 configuration requires at least two hard drives.

8) PWR_LED (System Power LED Header)

This header can be used to connect a system power LED on the chassis to indicate system power status. The LED is on when the system is operating. The LED keeps blinking when the system is in S1 sleep state. The LED is off when the system is in S3/S4 sleep state or powered off (S5).

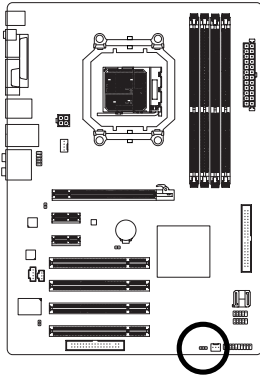

1 

Pin No.	Definition
1	MPD+
2	MPD-
3	MPD-

System Status	LED
S0	On
S1	Blinking
S3/S4/S5	Off

9) BATTERY

The battery provides power to keep the values (such as BIOS configurations, date, and time information) in the CMOS when the computer is turned off. Replace the battery when the battery voltage drops to a low level, or the CMOS values may not be accurate or may be lost.

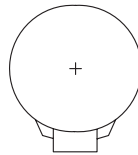
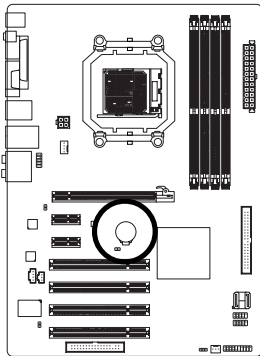

You may clear the CMOS values by removing the battery:

1. Turn off your computer and unplug the power cord.
2. Gently remove the battery from the battery holder and wait for one minute.
(Or use a metal object like a screwdriver to touch the positive and negative terminals of the battery holder, making them short for 5 seconds.)
3. Replace the battery.
4. Plug in the power cord and restart your computer.



- Always turn off your computer and unplug the power cord before replacing the battery.
- Replace the battery with an equivalent one. Danger of explosion if the battery is replaced with an incorrect model.
- Contact the place of purchase or local dealer if you are not able to replace the battery by yourself or uncertain about the battery model.
- When installing the battery, note the orientation of the positive side (+) and the negative side (-) of the battery (the positive side should face up).
- Used batteries must be handled in accordance with local environmental regulations.

10) F_PANEL (Front Panel Header)

Connect the power switch, reset switch, speaker and system status indicator on the chassis front panel to this header according to the pin assignments below. Note the positive and negative pins before connecting the cables.

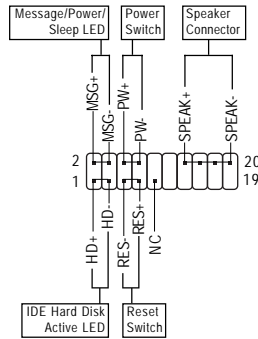
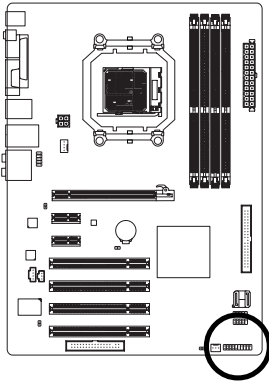

- MSG (Message/Power/Sleep LED, Yellow):

System Status	LED
S0	On
S1	Blinking
S3/S4/S5	Off

Connects to the power status indicator on the chassis front panel. The LED is on when the system is operating. The LED keeps blinking when the system is in S1 sleep state. The LED is off when the system is in S3/S4 sleep state or powered off (S5).

- PW (Power Switch, Red):
Connects to the power switch on the chassis front panel. You may configure the way to turn off your system using the power switch (refer to Chapter 2, "BIOS Setup," "Power Management Setup," for more information).
- SPEAK (Speaker, Orange):
Connects to the speaker on the chassis front panel. The system reports system startup status by issuing a beep code. One single short beep will be heard if no problem is detected at system startup. If a problem is detected, the BIOS may issue beeps in different patterns to indicate the problem. Refer to Chapter 5, "Troubleshooting," for information about beep codes.
- HD (IDE Hard Drive Activity LED, Blue)
Connects to the hard drive activity LED on the chassis front panel. The LED is on when the hard drive is reading or writing data.
- RES (Reset Switch, Green):
Connects to the reset switch on the chassis front panel. Press the reset switch to restart the computer if the computer freezes and fails to perform a normal restart.
- NC (Purple):
No connection



The front panel design may differ by chassis. A front panel module mainly consists of power switch, reset switch, power LED, hard drive activity LED, speaker and etc. When connecting your chassis front panel module to this header, make sure the wire assignments and the pin assignments are matched correctly.

11) F_AUDIO (Front Panel Audio Header)

The front panel audio header supports Intel High Definition audio (HD) and AC'97 audio. You may connect your chassis front panel audio module to this header. Make sure the wire assignments of the module connector match the pin assignments of the motherboard header. Incorrect connection between the module connector and the motherboard header will make the device unable to work or even damage it.

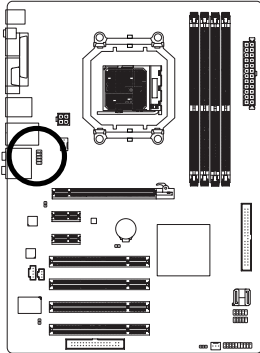

For HD Front Panel Audio:

Pin No.	Definition
1	MIC2_L
2	GND
3	MIC2_R
4	-ACZ_DET
5	LINE2_R
6	FSENSE1
7	FAUDIO_JD
8	No Pin
9	LINE2_L
10	FSENSE2

For AC'97 Front Panel Audio:

Pin No.	Definition
1	MIC
2	GND
3	MIC Power
4	NC
5	Line Out (R)
6	NC
7	NC
8	No Pin
9	Line Out (L)
10	NC



- The front panel audio header supports HD audio by default. If your chassis provides an AC'97 front panel audio module, refer to the instructions on how to activate AC'97 functionality via the audio software in Chapter 5, "Configuring 2/4/5.1/7.1-Channel Audio."
- When using an AC'97 front panel audio module, you can use either the front or the back panel audio connectors, but not both at the same time.
- Some chassis provide a front panel audio module that has separated connectors on each wire instead of a single plug. For information about connecting the front panel audio module that has different wire assignments, please contact the chassis manufacturer.

12) CD_IN (CD In Connector, Black)

You may connect the audio cable that came with your optical drive to the header.

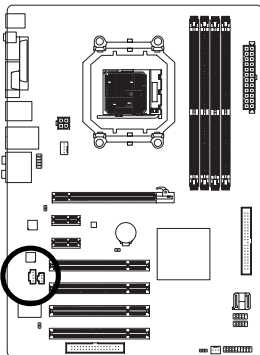

Pin No.	Definition
1	CD-L
2	GND
3	GND
4	CD-R

13) SPDIF_I (S/PDIF In Header, Red)

This header supports digital S/PDIF in and can connect to an audio device that supports digital audio out via an optional S/PDIF in cable. For purchasing the optional S/PDIF in cable, please contact the local dealer.

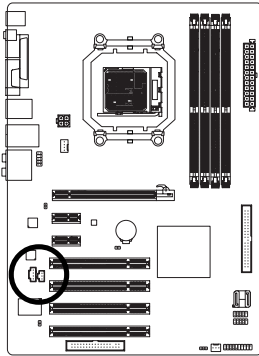

Pin No.	Definition
1	Power
2	SPDIFI
3	GND

14) SPDIF_O (S/PDIF Out Header)

This header supports digital S/PDIF out and connects a S/PDIF digital audio cable (provided by expansion cards) for digital audio output from your motherboard to certain expansion cards like graphics cards and sound cards. For example, some graphics cards may require you to use a S/PDIF digital audio cable for digital audio output from your motherboard to your graphics card if you wish to connect an HDMI display to the graphics card and have digital audio output from the HDMI display at the same time. For information about connecting the S/PDIF digital audio cable, carefully read the manual for your expansion card.

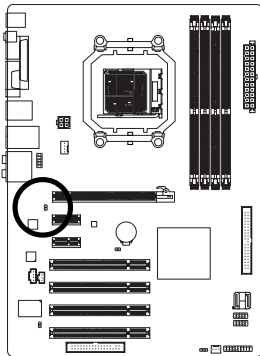

Pin No.	Definition
1	SPDIFO
2	GND

15) F_USB1/F_USB2 (USB Headers, Yellow)

The headers conform to USB 2.0/1.1 specification. Each USB header can provide two USB ports via an optional USB bracket. For purchasing the optional USB bracket, please contact the local dealer.

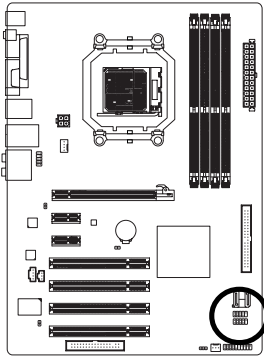

Pin No.	Definition
1	Power (5V)
2	Power (5V)
3	USB DX-
4	USB DY-
5	USB DX+
6	USB DY+
7	GND
8	GND
9	No Pin
10	NC



- Do not plug the IEEE 1394 bracket (2x5-pin) cable into the USB header.
- Prior to installing the USB bracket, be sure to turn off your computer and unplug the power cord from the power outlet to prevent damage to the USB bracket.

16) CI (Chassis Intrusion Header)

This motherboard provides a chassis detection feature that detects if the chassis cover has been removed. This function requires a chassis with chassis intrusion detection design.

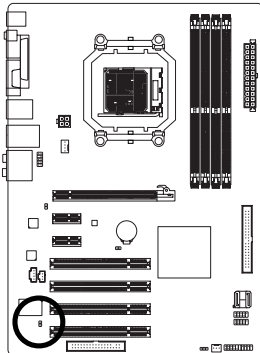



Pin No.	Definition
1	Signal
2	GND

17) CLR_CMOS (Clearing CMOS Jumper)

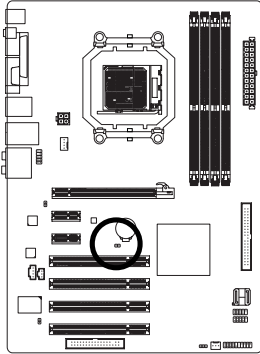
Use this jumper to clear the CMOS values (e.g. date information and BIOS configurations) and reset the CMOS values to factory defaults. To clear the CMOS values, place a jumper cap on the two pins to temporarily short the two pins or use a metal object like a screwdriver to touch the two pins for a few seconds.



 Open: Normal

 Short: Clear CMOS Values



- Always turn off your computer and unplug the power cord from the power outlet before clearing the CMOS values.
- After clearing the CMOS values and before turning on your computer, be sure to remove the jumper cap from the jumper. Failure to do so may cause damage to the motherboard.
- After system restart, go to BIOS Setup to load factory defaults (select **Load Optimized Defaults**) or manually configure the BIOS settings (refer to Chapter 2, "BIOS Setup," for BIOS configurations).

Chapter 2 BIOS Setup

BIOS (Basic Input and Output System) records hardware parameters of the system in the CMOS on the motherboard. Its major functions include conducting the Power-On Self-Test (POST) during system startup, saving system parameters and loading operating system, etc. BIOS includes a BIOS Setup program that allows the user to modify basic system configuration settings or to activate certain system features. When the power is turned off, the battery on the motherboard supplies the necessary power to the CMOS to keep the configuration values in the CMOS.

To access the BIOS Setup program, press the <Delete> key during the POST when the power is turned on. To see more advanced BIOS Setup menu options, you can press <Ctrl> + <F1> in the main menu of the BIOS Setup program.

To upgrade the BIOS, use either the GIGABYTE Q-Flash or @BIOS utility.

- Q-Flash allows the user to quickly and easily upgrade or back up BIOS without entering the operating system.
- @BIOS is a Windows-based utility that searches and downloads the latest version of BIOS from the Internet and updates the BIOS.

For instructions on using the Q-Flash and @BIOS utilities, refer to Chapter 4, "BIOS Update Utilities."



- Because BIOS flashing is potentially risky, if you do not encounter problems using the current version of BIOS, it is recommended that you not flash the BIOS. To flash the BIOS, do it with caution. Inadequate BIOS flashing may result in system malfunction.
- BIOS will emit a beep code during the POST. Refer to Chapter 5, "Troubleshooting," for the beep codes description.
- It is recommended that you not alter the default settings (unless you need to) to prevent system instability or other unexpected results. Inadequately altering the settings may result in system's failure to boot. If this occurs, try to clear the CMOS values and reset the board to default values. (Refer to the "Load Optimized Defaults" section in this chapter or introductions of the battery/clearing CMOS jumper in Chapter 1 for how to clear the CMOS values.)

2-1 Startup Screen

The following screens may appear when the computer boots.

A. The LOGO Screen (Default)

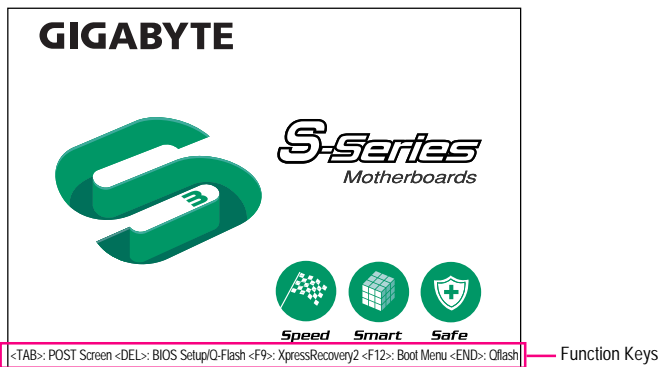

B. The POST Screen

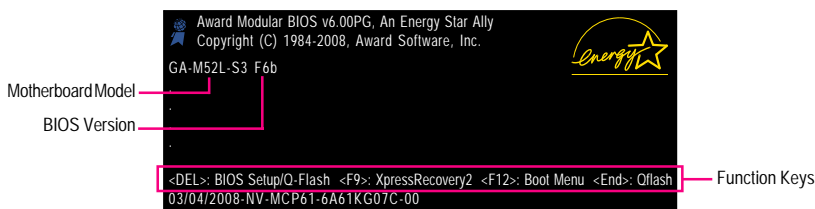

Function Keys:

<TAB>: POST Screen

Press the <Tab> key to show the BIOS POST screen. To show the BIOS POST screen at system startup, refer to the instructions on the **Full Screen LOGO Show** item on page 38.

: BIOS Setup/Q-Flash

Press the <Delete> key to enter BIOS Setup or to access the Q-Flash utility in BIOS Setup.

<F9>: Xpress Recovery2

If you have ever entered Xpress Recovery2 to back up hard drive data using the motherboard driver disk, the <F9> key can be used for subsequent access to XpressRecovery2 during the POST. For more information, refer to Chapter 4, "Xpress Recovery2."

<F12>: Boot Menu

Boot Menu allows you to set the first boot device without entering BIOS Setup. In Boot Menu, use the up arrow key <↑> or the down arrow key <↓> to select the first boot device, then press <Enter> to accept. To exit Boot Menu, press <Esc>. The system will directly boot from the device configured in Boot Menu.

Note: The setting in Boot Menu is effective for one time only. After system restart, the device boot order will still be based on BIOS Setup settings. You can access Boot Menu again to change the first boot device setting as needed.

<End>: Q-Flash

Press the <End> key to access the Q-Flash utility directly without having to enter BIOS Setup first.

2-2 The Main Menu

Once you enter the BIOS Setup program, the Main Menu (as shown below) appears on the screen. Use arrow keys to move among the items and press <Enter> to accept or enter a sub-menu.

(Sample BIOS Version: F6b)

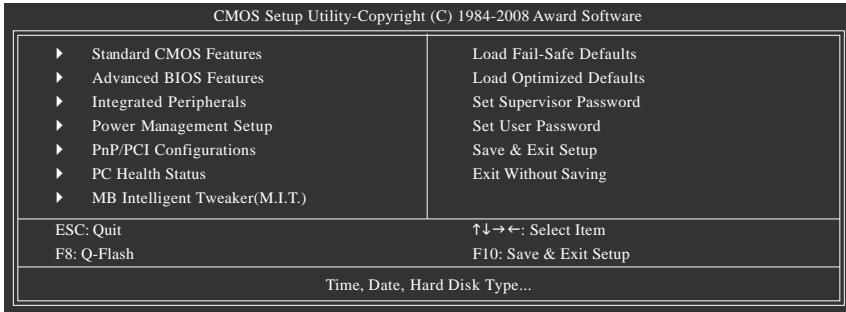

BIOS Setup Program Function Keys

<↑><↓><←><→>	Move the selection bar to select an item
<Enter>	Execute command or enter the submenu
<Esc>	Main Menu: Exit the BIOS Setup program Submenus: Exit current submenu
<Page Up>	Increase the numeric value or make changes
<Page Down>	Decrease the numeric value or make changes
<F1>	Show descriptions of the function keys
<F2>	Move cursor to the Item Help block on the right (submenu only)
<F5>	Restore the previous BIOS settings for the current submenu
<F6>	Load the Fail-Safe BIOS default settings for the current submenu
<F7>	Load the Optimized BIOS default settings for the current submenu
<F8>	Access the Q-Flash utility
<F9>	Display system information
<F10>	Save all the changes and exit the BIOS Setup program

Main Menu Help

The onscreen description of a highlighted setup option is displayed on the bottom line of the Main Menu.

Submenu Help

While in a submenu, press <F1> to display a help screen (General Help) of function keys available for the menu. Press <Esc> to exit the help screen. Help for each item is in the Item Help block on the right side of the submenu.



- If you do not find the settings you want in the Main Menu or a submenu, press <Ctrl>+<F1> to access more advanced options.
- When the system is not stable as usual, select the **Load Optimized Defaults** item to set your system to its defaults.
- The BIOS Setup menus described in this chapter are for reference only and may differ by BIOS version.

■ Standard CMOS Features

Use this menu to configure the system time and date, hard drive types, floppy disk drive types, and the type of errors that stop the system boot, etc.

■ Advanced BIOS Features

Use this menu to configure the device boot order, advanced features available on the CPU, and the primary display adapter.

■ Integrated Peripherals

Use this menu to configure all peripheral devices, such as IDE, SATA, USB, integrated audio, and integrated LAN, etc.

■ Power Management Setup

Use this menu to configure all the power-saving functions.

■ PnP/PCI Configurations

Use this menu to configure the system's PCI & PnP resources.

■ PC Health Status

Use this menu to see information about autodetected system/CPU temperature, system voltage and fan speed, etc.

■ MB Intelligent Tweaker(M.I.T.)

Use this menu to configure the clock, frequency and voltages of your CPU, memory, etc.

■ Load Fail-Safe Defaults

Fail-Safe defaults are factory settings for the most stable, minimal-performance system operations.

■ Load Optimized Defaults

Optimized defaults are factory settings for optimal-performance system operations.

■ Set Supervisor Password

Change, set, or disable password. It allows you to restrict access to the system and BIOS Setup. A supervisor password allows you to make changes in BIOS Setup.

■ Set User Password

Change, set, or disable password. It allows you to restrict access to the system and BIOS Setup. An user password only allows you to view the BIOS settings but not to make changes.

■ Save & Exit Setup

Save all the changes made in the BIOS Setup program to the CMOS and exit BIOS Setup. (Pressing <F10> can also carry out this task.)

■ Exit Without Saving

Abandon all changes and the previous settings remain in effect. Pressing <Y> to the confirmation message will exit BIOS Setup. (Pressing <Esc> can also carry out this task.)

2-3 Standard CMOS Features

CMOS Setup Utility-Copyright (C) 1984-2008 Award Software Standard CMOS Features		
Date (mm:dd:yy)	Tue, Mar 18 2008	Item Help
Time (hh:mm:ss)	11:52:24	Menu Level▶
▶ IDE Channel 0 Master	[None]	
▶ IDE Channel 0 Slave	[None]	
▶ IDE Channel 2 Master	[None]	
▶ IDE Channel 3 Master	[None]	
Drive A	[1.44M, 3.5"]	
Floppy 3 Mode Support	[Disabled]	
Halt On	[All, But Keyboard]	
Base Memory	640K	
Extended Memory	511M	

↑↓→←: Move Enter: Select +/-/PU/PD: Value F10: Save ESC: Exit F1: General Help
 F5: Previous Values F6: Fail-Safe Default F7: Optimized Defaults

☞ Date

Sets the system date. The date format is week (read-only), month, date and year. Select the desired field and use the up arrow or down arrow key to set the date.

☞ Time

Sets the system time. For example, 1 p.m. is 13:0:0. Select the desired field and use the up arrow or down arrow key to set the time.

☞ IDE Channel 0 Master/Slave

▶▶ IDE HDD Auto-Detection

Press <Enter> to autodetect the parameters of the IDE/SATA device on this channel.

▶▶ IDE Channel 0 Master/Slave

Configure your IDE/SATA devices by using one of the three methods below:

- Auto Lets BIOS automatically detect IDE/SATA devices during the POST. (Default)
- None If no IDE/SATA devices are used, set this item to **None** so the system will skip the detection of the device during the POST for faster system startup.
- Manual Allows you to manually enter the specifications of the hard drive when the hard drive access mode is set to **CHS**.

▶▶ Access Mode Sets the hard drive access mode. Options are: Auto (default), CHS, LBA, Large.

☞ IDE Channel 2/3 Master

▶▶ IDE Auto-Detection

Press <Enter> to autodetect the parameters of the IDE/SATA device on this channel.

- ▶▶ Extended IDE Drive Configure your IDE/SATA devices using one of the two methods below:
- Auto Lets BIOS automatically detect IDE/SATA devices during the POST. (Default)
 - None If no IDE/SATA devices are used, set this item to **None** so the system will skip the detection of the device during the POST for faster system startup.

▶▶ Access Mode Sets the hard drive access mode. Options are: Auto (default), Large.

The following fields display your hard drive specifications. If you wish to enter the parameters manually, refer to the information on the hard drive.

- ▶▶ Capacity Approximate capacity of the currently installed hard drive.
- ▶▶ Cylinder Number of cylinders.
- ▶▶ Head Number of heads.
- ▶▶ Precomp Write precompensation cylinder.
- ▶▶ Landing Zone Landing zone.
- ▶▶ Sector Number of sectors.

☞ Drive A

Allows you to select the type of floppy disk drive installed in your system. If you do not install a floppy disk drive, set this item to **None**. Options are: None, 360K/5.25", 1.2M/5.25", 720K/3.5", 1.44M/3.5", 2.88M/3.5".

☞ Floppy 3 Mode Support

Allows you to specify whether the installed floppy disk drive is 3-mode floppy disk drive, a Japanese standard floppy disk drive. Options are: Disabled (default), Drive A.

☞ Halt On

Allows you to determine whether the system will stop for an error during the POST.

- ▶▶ No Errors The system boot will not stop for any error.
- ▶▶ All Errors Whenever the BIOS detects a non-fatal error the system boot will stop.
- ▶▶ All, But Keyboard The system boot will not stop for a keyboard error but stop for all other errors. (Default)
- ▶▶ All, But Diskette The system boot will not stop for a floppy disk drive error but stop for all other errors.
- ▶▶ All, But Disk/Key The system boot will not stop for a keyboard or a floppy disk drive error but it will stop for all other errors.

☞ Memory

These fields are read-only and are determined by the BIOS POST.

- ▶▶ Base Memory Also called conventional memory. Typically, 640 KB will be reserved for the MS-DOS operating system.
- ▶▶ Extended Memory The amount of extended memory.

2-4 Advanced BIOS Features

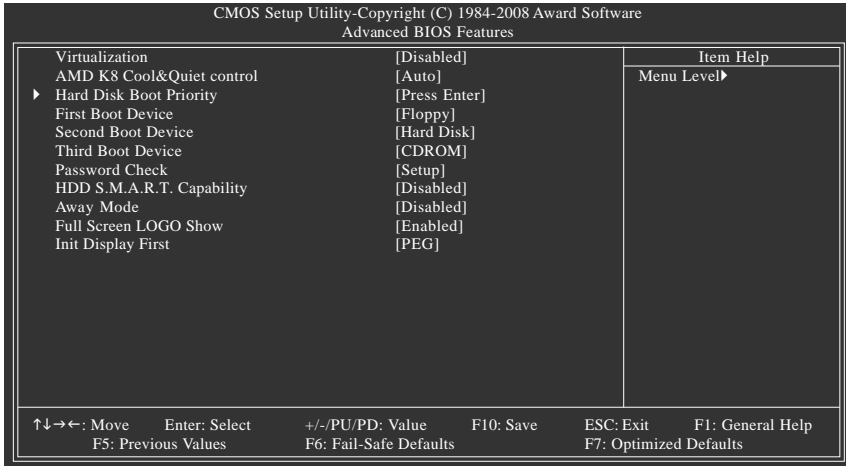

Virtualization

Virtualization allows a platform to run multiple operating systems and applications in independent partitions. With virtualization, one computer system can function as multiple virtual systems. (Default: Disabled)

AMD K8 Cool&Quiet control

- ▶ Auto Lets the AMD Cool'n'Quiet driver dynamically adjust the CPU clock and VIA to reduce heat output from your computer and its power consumption. (Default)
- ▶ Disabled Disable this function.

Hard Disk Boot Priority

Specifies the sequence of loading the operating system from the installed hard drives. Use the up or down arrow key to select a hard drive, then press the plus key <+> (or <PageUp>) or the minus key <-> (or <PageDown>) to move it up or down on the list. Press <Esc> to exit this menu when finished.

First/Second/Third Boot Device

Specifies the boot order from the available devices. Use the up or down arrow key to select a device and press <Enter> to accept. Options are: Floppy, LS120, Hard Disk, CDROM, ZIP, USB-FDD, USB-ZIP, USB-CDROM, USB-HDD, Legacy LAN, Disabled.

Password Check

Specifies whether a password is required every time the system boots, or only when you enter BIOS Setup. After configuring this item, set the password(s) under the **Set Supervisor/User Password** item in the BIOS Main Menu.

- ▶ Setup A password is only required for entering the BIOS Setup program. (Default)
- ▶ System A password is required for booting the system and for entering the BIOS Setup program.

☞ **HDD S.M.A.R.T. Capability**

Enables or disables the S.M.A.R.T. (Self Monitoring and Reporting Technology) capability of your hard drive. This feature allows your system to report read/write errors of the hard drive and to issue warnings when a third party hardware monitor utility is installed. (Default: Disabled)

☞ **Away Mode**

Enables or disables Away Mode in Windows XP Media Center operating system. Away Mode allows the system to silently perform unattended tasks while in a low-power mode that appears off (Default: Disabled)

☞ **Full Screen LOGO Show**

Allows you to determine whether to display the GIGABYTE Logo at system startup. **Disabled** displays normal POST message. (Default: Enabled)

☞ **Init Display First**

Specifies the first initiation of the monitor display from the installed PCI graphics card or the PCI Express graphics card.

- ▶▶ PCI Slot Sets the PCI graphics card as the first display.
- ▶▶ PEG Sets the PCI Express graphics card as the first display. (Default)

2-5 Integrated Peripherals

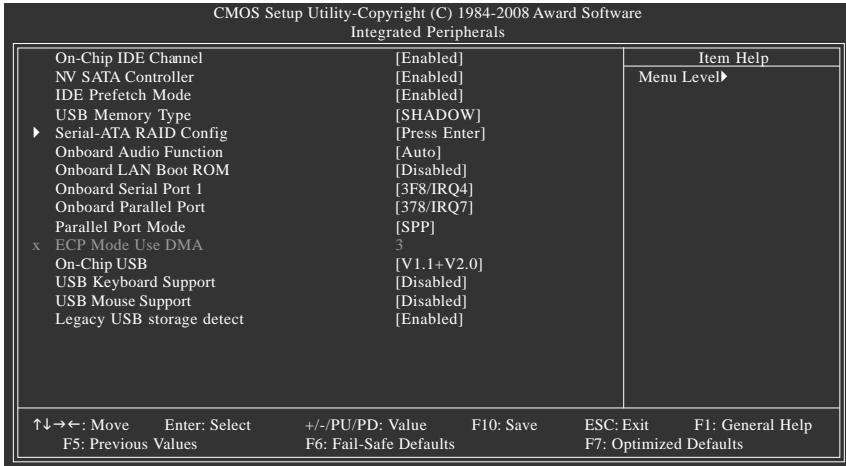

☞ On-Chip IDE Channel

Enables or disables the integrated IDE controller. (Default: Enabled)

☞ NV SATA Controller

Enables or disables the integrated SATA 3Gb/s controller. (Default: Enabled)

☞ IDE Prefetch Mode

Enables or disables prefetch mode for the integrated IDE controller. **Enabled** activates the IDE prefetch buffer to enhance hard drive performance. (Default: Enabled)

☞ USB Memory Type

Specifies the type of memory allocated for USB devices. Options are: SHADOW (default), Base Memory (640K).

☞ Serial-ATA RAID Config

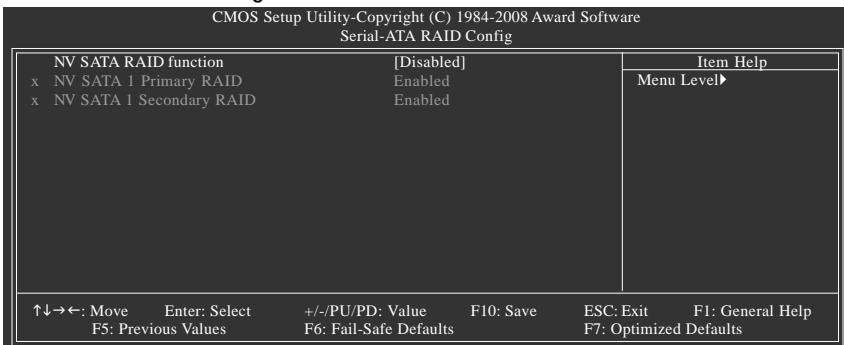

☞ **NV SATA RAID function**

Enables or disables RAID for the integrated SATA 3Gb/s controller. **Enabled** allows you to configure RAID for individual SATA channel. (Default: Disabled)

☞ **NV SATA 1 Primary RAID**

Enables or disables RAID for the first channel of the integrated SATA 3Gb/s controller. This item is configurable only if the **NV SATA RAID function** item is set to **Enabled**. (Default: Enabled)

☞ **NV SATA 1 Secondary RAID**

Enables or disables RAID for the second channel of the integrated SATA 3Gb/s controller. This item is configurable only if the **NV SATA RAID function** item is set to **Enabled**.

☞ **Onboard Audio Function**

Enables or disables the onboard audio function. (Default: Auto)

If you wish to install a 3rd party add-in audio card instead of using the onboard audio, set this item to **Disabled**.

☞ **Onboard LAN Boot ROM**

Allows you to decide whether to activate the boot ROM integrated with the onboard LAN chip. (Default: Disabled)

☞ **Onboard Serial Port 1**

Enables or disables the first serial port and specifies its base I/O address and corresponding interrupt. Options are: Auto, 3F8/IRQ4 (default), 2F8/IRQ3, 3E8/IRQ4, 2E8/IRQ3, Disabled.

☞ **Onboard Parallel Port**

Enables or disables the onboard parallel port (LPT) and specifies its base I/O address and corresponding interrupt. Options are: 378/IRQ7 (default), 278/IRQ5, 3BC/IRQ7, Disabled.

☞ **Parallel Port Mode**

Selects an operating mode for the onboard parallel (LPT) port. Options are: SPP (Standard Parallel Port)(default), EPP (Enhanced Parallel Port), ECP (Extended Capabilities Port), ECP+EPP.

☞ **ECP Mode Use DMA**

Selects DMA channel for the LPT port in ECP mode. This item is configurable only if **Parallel Port Mode** is set to **ECP** or **ECP+EPP** mode. Options are: 3 (default), 1.

☞ **On-Chip USB**

Configures the integrated USB controller.

▶▶ V1.1+V2.0 Enables the integrated USB 1.1 and USB 2.0 controllers. (Default)

▶▶ V1.1 Enables only the integrated USB 1.1 controller.

▶▶ Disabled Disables the integrated USB 1.1 and USB 2.0 controllers.

Disabled will turn off all of the USB functionalities below.

☞ **USB Keyboard Support**

Allows USB keyboard to be used in MS-DOS. (Default: Disabled)

☞ **USB Mouse Support**

Allows USB mouse to be used in MS-DOS. (Default: Disabled)

☞ **Legacy USB storage detect**

Determines whether to detect USB storage devices, including USB flash drives and USB hard drives during the POST. (Default: Enabled)

2-6 Power Management Setup

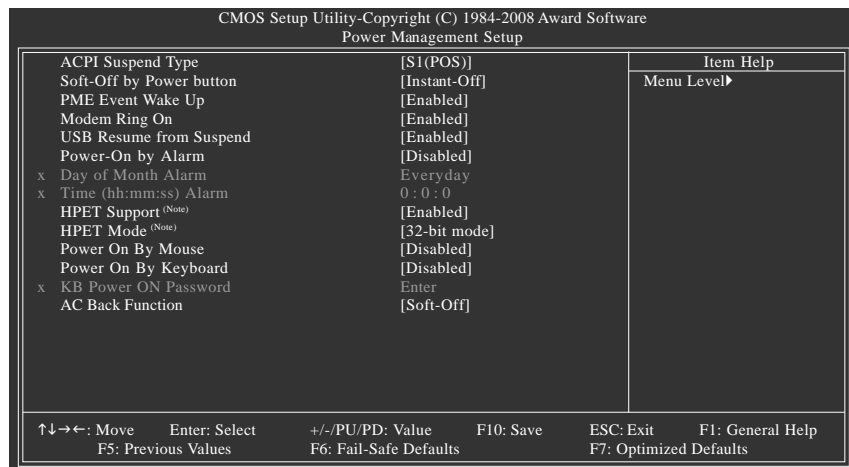

☞ ACPI Suspend Type

Specifies the ACPI sleep state when the system enters suspend.

- ▶▶ S1(POS) Enables the system to enter the ACPI S1 (Power on Suspend) sleep state (default). In S1 sleep state, the system appears suspended and stays in a low power mode. The system can be resumed at any time.
- ▶▶ S3(STR) Enables the system to enter the ACPI S3 (Suspend to RAM) sleep state. In S3 sleep state, the system appears to be off and consumes less power than in the S1 state. When signaled by a wake-up device or event, the system resumes to its working state exactly where it was left off.

☞ Soft-Off by Power button

Configures the way to turn off the computer in MS-DOS mode using the power button.

- ▶▶ Instant-Off Press the power button and then the system will be turned off instantly. (Default)
- ▶▶ Delay 4 Sec. Press and hold the power button for 4 seconds to turn off the system. If the power button is pressed for less than 4 seconds, the system will enter suspend mode.

☞ PME Event Wake Up

Allows the system to be awakened from an ACPI sleep state by a wake-up signal from a PCI or PCIe device. Note: To use this function, you need an ATX power supply providing at least 1A on the +5VSB lead. (Default: Enabled)

☞ Modem Ring On

Allows the system to be awakened from an ACPI sleep state by a wake-up signal from a modem that supports wake-up function. (Default: Enabled)

(Note) Supported on Windows® Vista® operating system only.

☞ **USB Resume from Suspend**

Allows the system to be awakened from ACPI S3 sleep state by a wake-up signal from the installed USB device. (Default: Enabled)

☞ **Power-On by Alarm**

Determines whether to power on the system at a desired time. (Default: Disabled)

If enabled, set the date and time as following:

▶▶ Day of Month Alarm: Turn on the system at a specific time on each day or on a specific day in a month.

▶▶ Time (hh: mm: ss) Alarm: Set the time at which the system will be powered on automatically.

Note: When using this function, avoid inadequate shutdown from the operating system or removal of the AC power, or the settings may not be effective.

☞ **HPET Support** ^(Note)

Enables or disables High Precision Event Timer (HPET) for Windows® Vista® operating system. (Default: Enabled)

☞ **HPET Mode** ^(Note)

Allows you to select the HPET mode for your Windows® Vista® operating system. Select **32-bit** mode when you install 32-bit Windows® Vista®; select **64-bit** mode when you install 64-bit Windows® Vista®. (Default: 32-bit mode)

☞ **Power On By Mouse**

Allows the system to be turned on by a PS/2 mouse wake-up event.

Note: To use this function, you need an ATX power supply providing at least 1A on the +5VSB lead.

▶▶ Disabled Disables this function. (Default)

▶▶ Double Click Double click on left button on the PS/2 mouse to turn on the system.

☞ **Power On By Keyboard**

Allows the system to be turned on by a PS/2 keyboard wake-up event.

Note: you need an ATX power supply providing at least 1A on the +5VSB lead.

▶▶ Disabled Disables this function. (Default)

▶▶ Password Set a password with 1~5 characters to turn on the system.

▶▶ Any KEY Press any key on the keyboard to turn on the system.

▶▶ Keyboard 98 Press POWER button on the Windows 98 keyboard to turn on the system.

☞ **KB Power ON Password**

Set the password when **Power On by Keyboard** is set to **Password**. Press <Enter> on this item and set a password with up to 5 characters and then press <Enter> to accept. To turn on the system, enter the password and press <Enter>.

Note: To cancel the password, press <Enter> on this item. When prompted for the password, press <Enter> again without entering the password to clear the password settings.

☞ **AC Back Function**

Determines the state of the system after the return of power from an AC power loss.

▶▶ Soft-Off The system stays off upon the return of the AC power. (Default)

▶▶ Full-On The system is turned on upon the return of the AC power.

(Note) Supported on Windows® Vista® operating system only.

2-7 PnP/PCI Configurations

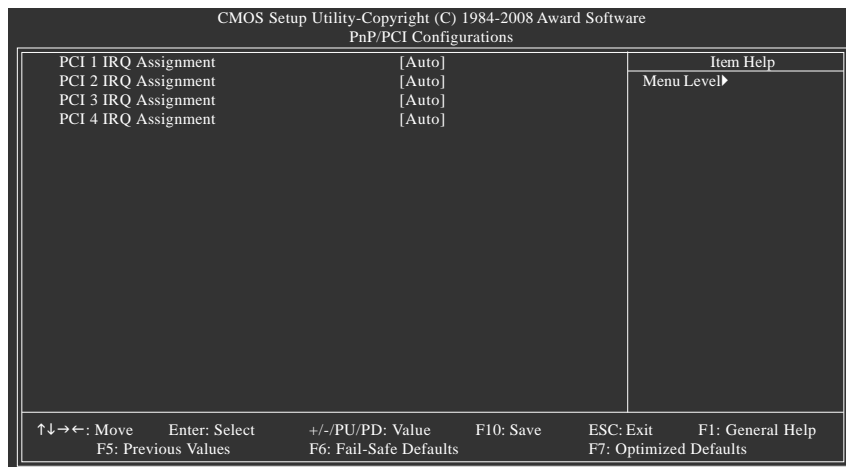

☞ PCI 1 IRQ Assignment

- ▶▶ Auto BIOS auto-assigns IRQ to the first PCI slot. (Default)
- ▶▶ 3,4,5,7,9,10,11,12,14,15 Assigns IRQ 3,4,5,7,9,10,11,12,14,15 to the first PCI slot.

☞ PCI 2 IRQ Assignment

- ▶▶ Auto BIOS auto-assigns IRQ to the second PCI slot. (Default)
- ▶▶ 3,4,5,7,9,10,11,12,14,15 Assigns IRQ 3,4,5,7,9,10,11,12,14,15 to the second PCI slot.

☞ PCI 3 IRQ Assignment

- ▶▶ Auto BIOS auto-assigns IRQ to the third PCI slot. (Default)
- ▶▶ 3,4,5,7,9,10,11,12,14,15 Assigns IRQ 3,4,5,7,9,10,11,12,14,15 to the third PCI slot.

☞ PCI 4 IRQ Assignment

- ▶▶ Auto BIOS auto-assigns IRQ to the fourth PCI slot. (Default)
- ▶▶ 3,4,5,7,9,10,11,12,14,15 Assigns IRQ 3,4,5,7,9,10,11,12,14,15 to the fourth PCI slot.

2-8 PC Health Status

CMOS Setup Utility-Copyright (C) 1984-2008 Award Software		Item Help
PC Health Status		Menu Level▶
Reset Case Open Status	[Disabled]	
Case Opened	Yes	
Vcore	OK	
DDR2 1.8V	OK	
+3.3V	OK	
+12V	OK	
Current System Temperature	32°C	
Current CPU Temperature	45°C	
Current CPU FAN Speed	3245 RPM	
Current SYSTEM FAN Speed	0 RPM	
System Warning Temperature	[Disabled]	
CPU Warning Temperature	[Disabled]	
CPU FAN Fail Warning	[Disabled]	
SYSTEM FAN Fail Warning	[Disabled]	
CPU Smart FAN Control	[Enabled]	
CPU Smart FAN Mode	[Auto]	
System Smart FAN Control	[Enabled]	

↑↓←→: Move Enter: Select +/-/PU/PD: Value F10: Save ESC: Exit F1: General Help
 F5: Previous Values F6: Fail-Safe Defaults F7: Optimized Defaults

Reset Case Open Status

Keeps or clears the record of previous chassis intrusion status. **Enabled** clears the record of previous chassis intrusion status and the **Case Opened** field will show "No" at next boot. (Default: Disabled)

Case Opened

Displays the detection status of the chassis intrusion detection device attached to the motherboard CI header. If the system chassis cover is removed, this field will show "Yes", otherwise it will show "No". To clear the chassis intrusion status record, set **Reset Case Open Status** to **Enabled**, save the settings to CMOS, and then restart your system.

Current Voltage(V) Vcore/DDR2 1.8V/+3.3V/+12V

Displays the current system voltages.

Current System/CPU Temperature

Displays current system/CPU temperature.

Current CPU/SYSTEM FAN Speed (RPM)

Displays current CPU/system fan speed.

System/CPU Warning Temperature

Sets the warning threshold for system/CPU temperature. When system/CPU temperature exceeds the threshold, BIOS will emit warning sound. Options are: Disabled (default), 60°C/140°F, 70°C/158°F, 80°C/176°F, 90°C/194°F.

CPU/SYSTEM FAN Fail Warning

Allows the system to emit warning sound if the CPU/system fan is not connected or fails. Check the fan condition or fan connection when this occurs. (Default: Disabled)

CPU Smart FAN Control

Enables or disables the CPU fan speed control function. **Enabled** allows the CPU fan to run at different speed according to the CPU temperature. You can adjust the fan speed with EasyTune based on system requirements. If disabled, CPU fan runs at full speed. (Default: Enabled)

☞ CPU Smart FAN Mode

Specifies how to control CPU fan speed. This item is configurable only if **CPU Smart FAN Control** is set to **Enabled**.

- ▶▶ Auto Lets BIOS autodetect the type of CPU fan installed and sets the optimal CPU fan control mode. (Default)
- ▶▶ Voltage Sets Voltage mode for a 3-pin CPU fan.
- ▶▶ PWM Sets PWM mode for a 4-pin CPU fan.

☞ System Smart FAN Control

Enables or disables the system fan speed control function. **Enabled** allows the system fan to run at different speed according to the system temperature. You can adjust the fan speed with EasyTune based on system requirements. If disabled, system fan runs at full speed. (Default: Enabled)

2-9 MB Intelligent Tweaker(M.I.T.)

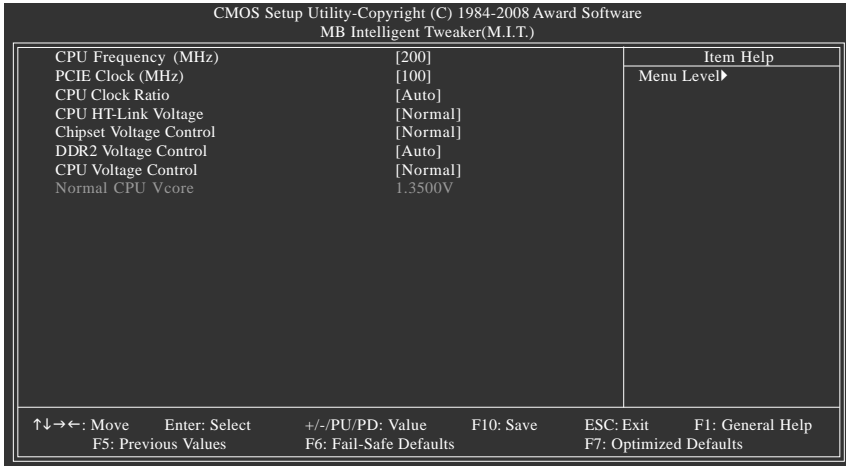

Incorrectly doing overclock/overvoltage may result in damage to CPU, chipset, or memory and reduce the useful life of these components. This page is for advanced users only and we recommend you not to alter the default settings to prevent system instability or other unexpected results. (Inadequately altering the settings may result in system's failure to boot. If this occurs, clear the CMOS values and reset the board to default values.)

☞ CPU Frequency (MHz)

Allows you to manually set the CPU host frequency.

Important It is highly recommended that the CPU frequency be set in accordance with the CPU specifications.

☞ PCIE Clock (MHz)

Allows you to manually set the PCIe clock frequency. The adjustable range is from 100 MHz to 145 MHz. (Default: 100)

☞ CPU Clock Ratio

Allows you to alter the clock ratio for the installed CPU. The adjustable range is dependent on the CPU being used.

☞ CPU HT-Link Voltage

Allows you to set the voltage of the HT-Link between the CPU and chipset.

▶ Normal Supplies the HT-Link voltage as required. (Default)

▶ +0.025V~+0.200V Increases the HT-Link by 0.025V to 0.200V.

☞ Chipset Voltage Control

Allows you to set the chipset voltage.

▶ Normal Supplies the chipset voltage as required. (Default)

▶ +0.025V~+0.200V Increases the chipset by 0.025V to 0.200V.

☞ **DDR2 Voltage Control**

Allows you to set memory voltage.

- ▶▶ Auto Supplies the memory voltage as required. (Default)
- ▶▶ +0.05V ~ +0.60V Increases memory voltage by 0.05V to 0.60V.

☞ **CPU Voltage Control**

Allows you to set the CPU voltage. **Normal** sets the CPU voltage as required. The adjustable range is dependent on the CPU being installed. (Default: Normal)

Note: Increasing CPU voltage may result in damage to your CPU or reduce the useful life of the CPU.

☞ **Normal CPU Vcore**

Displays the normal operating voltage of your CPU.

2-10 Load Fail-Safe Defaults

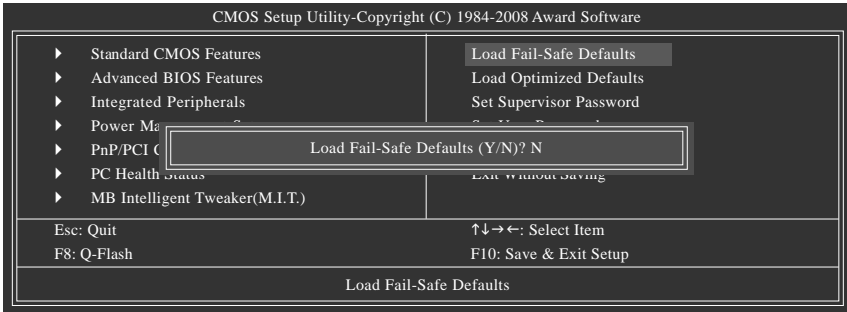

Press <Enter> on this item and then press the <Y> key to load the safest BIOS default settings. In case system instability occurs, you may try to load Fail-Safe defaults, which are the safest and most stable BIOS settings for the motherboard.

2-11 Load Optimized Defaults

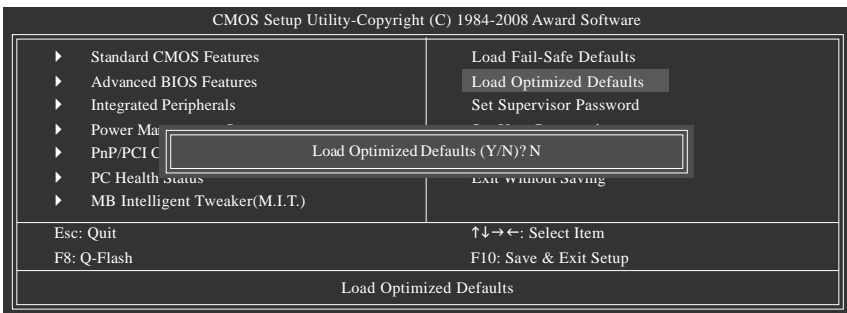

Press <Enter> on this item and then press the <Y> key to load the optimal BIOS default settings. The BIOS defaults settings helps the system to operate in optimum state. Always load the Optimized defaults after updating the BIOS or after clearing the CMOS values.

2-12 Set Supervisor/User Password

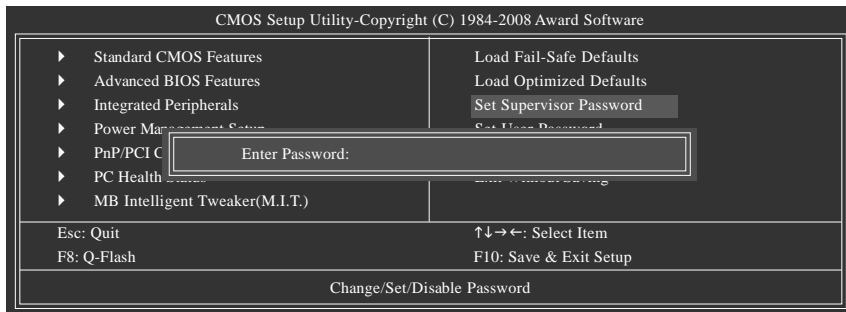

Press <Enter> on this item and type the password with up to 8 characters and then press <Enter>. You will be requested to confirm the password. Type the password again and press <Enter>.

The BIOS Setup program allows you to specify two separate passwords:

Supervisor Password

When a system password is set and the **Password Check** item in **Advanced BIOS Features** is set to **Setup**, you must enter the supervisor password for entering BIOS Setup and making BIOS changes.

When the **Password Check** item is set to **System**, you must enter the supervisor password (or user password) at system startup and when entering BIOS Setup.

User Password

When the **Password Check** item is set to **System**, you must enter the supervisor password (or user password) at system startup to continue system boot. In BIOS Setup, you must enter the supervisor password if you wish to make changes to BIOS settings. The user password only allows you to view the BIOS settings but not to make changes.

To clear the password, press <Enter> on the password item and when requested for the password, press <Enter> again. The message "PASSWORD DISABLED" will appear, indicating the password has been cancelled.

2-13 Save & Exit Setup

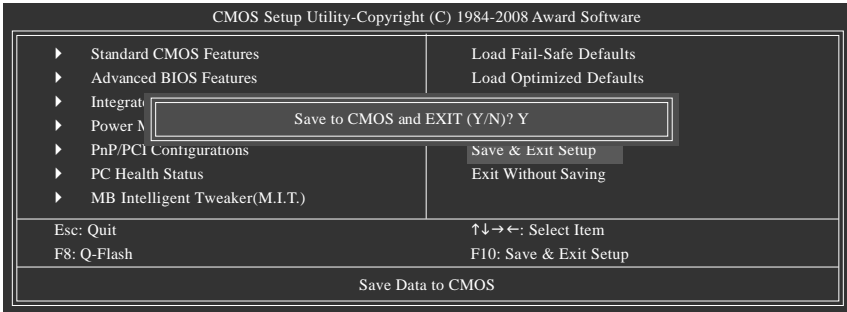

Press <Enter> on this item and press the <Y> key. This saves the changes to the CMOS and exits the BIOS Setup program. Press <N> or <Esc> to return to the BIOS Setup Main Menu.

2-14 Exit Without Saving

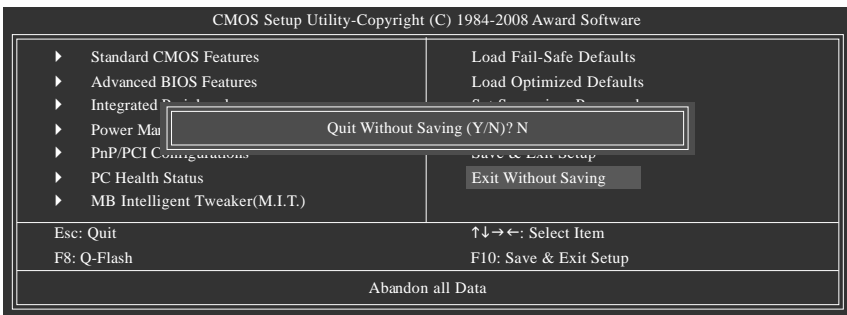

Press <Enter> on this item and press the <Y> key. This exits the BIOS Setup without saving the changes made in BIOS Setup to the CMOS. Press <N> or <Esc> to return to the BIOS Setup Main Menu.

Chapter 3 Drivers Installation



- Before installing the drivers, first install the operating system. (The following instructions use Windows XP as the example operating system.)
- After installing the operating system, insert the motherboard driver disk into your optional drive. The driver Autorun screen is automatically displayed which looks like that shown in the screen shot below. (If the driver Autorun screen does not appear automatically, go to My Computer, double-click the optical drive and execute the **Run.exe** program.)

3-1 Installing Chipset Drivers

"Xpress Install" is now analyzing your computer...99%

After inserting the driver disk, "Xpress Install" will automatically scan the system and then list all the drivers that are recommended to install. Please select the item that you wish to install and press the **Install** button following the item. Or you can press **Xpress Install** to install all the driver items.

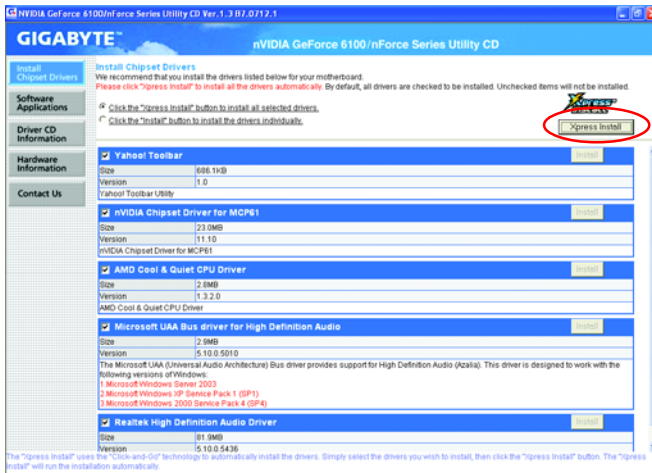

- Please ignore the popup dialog box(es) (e.g. the **Found New Hardware Wizard**) displayed when "Xpress Install" is installing the drivers. Failure to do so may affect the driver installation.
- Some device drivers will restart your system automatically during the driver installation. After the system restart, "Xpress Install" will continue to install other drivers.
- After the drivers are installed, follow the onscreen instructions to restart your system. You can install other applications included in the motherboard driver disk.
- For USB 2.0 driver support under the Windows XP operating system, please install the Windows XP Service Pack 1 or later. After installing the SP1 (or later), if a question mark still exists in **Universal Serial Bus Controller** in **Device Manager**, please remove the question mark (by right-clicking your mouse and select **Uninstall**) and restart the system. (The system will then autodetect and install the USB 2.0 driver.)

3-2 Software Applications

This page displays all the tools and applications that GIGABYTE develops and some free software. You may press the **Install** button following an item to install it.



GIGABYTE™ nVIDIA GeForce 6100/nForce Series Utility CD

Software Applications
Please click the following applications to install:

Application Name	Size	Install
Norton Internet Security (NIS)	48.6MB	Install
<p>Please install Windows Installer 3.1 before to install NIS in Windows XP SP2 Click to Download Windows Installer 3.1</p> <p>Norton Internet Security provides essential protection from viruses, hackers and privacy threats. It includes:</p> <ul style="list-style-type: none"> - Norton AntiVirus - Norton Personal Firewall - Norton Privacy Control - Norton AntiSpam - Norton Parental Control 		
Kaspersky antivirus	27.3MB	Install
Acrobat Reader	15.9MB	Install
NV Forceware Network Guide	11.5MB	Install
Nvidia Forceware Network Access Manager		Install

This page lists the value-added software developed by GIGABYTE and its worldwide partners.

3-3 Driver CD Information

This page provides information about the drivers, applications and tools in this driver disk.



GIGABYTE™ nVIDIA GeForce 6100/nForce Series Utility CD

Driver CD Information
The following shows the detailed information about the software and drivers included in the motherboard driver disk.

Category	Item Name	Description
Chipset	nVIDIA_Drv	nVIDIA System Driver
	IL_VGA	nVIDIA VGA Driver
	IDE	nVIDIA IDE Driver
	Coast Guard	AMD X3 CPU Driver for XP
	NU3B	USB 2.0 Driver for XP with SP1 and 2K with SP4
	XPR2	XPRESS Recovery 2 Patch File
	EnableUSB30p	Enable USB device back form B3 mode
Audio	Realtek	Realtek Audio Driver
	MSHD-OF-E	Microsoft UAA Bus Driver
	Network	NDIS
Novell		Novell client for DOS(ODI driver)
Realtek		Realtek LAN Driver
AMD		AMD LAN Driver

This page gives information about the software and drivers included in the motherboard driver disk.

3-4 Hardware Information

This page provides information about the hardware devices on this motherboard.



3-5 Contact Us

Check the contacts information of the GIGABYTE headquarter in Taiwan and the overseas branch offices on the last page of this manual.



Chapter 4 Unique Features

4-1 Xpress Recovery2



Xpress Recovery2 is a utility that allows you to quickly compress and back up your system data and perform restoration of it. Supporting NTFS, FAT32, and FAT16 file systems, Xpress Recovery2 can back up data on PATA and SATA hard drives and restore it.

Before You Begin:

- Xpress Recovery2 will check the first physical hard drive* for the operating system. Xpress Recovery2 can only back up/restore the first physical hard drive that has the operating system installed.
- As Xpress Recovery2 will save the backup file at the end of the hard drive, make sure to leave enough unallocated space in advanced (10 GB or more is recommended; actual size requirements vary, depending on the amount of data).
- It is recommended to back up your system soon after the operating system and drivers are installed.
- The amount of data and hard drive access speed may affect the speed at which the data is backed up/restored.
- It takes longer to back up a hard drive than to restore it.

System Requirements:

- AMD platform
- At least 64 MB of system memory
- VESA compatible graphics card
- Windows® 2000 with SP3 or later; Windows® XP with SP1 or later



- Xpress Recovery and Xpress Recovery2 are different utilities. For example, a backup file created with Xpress Recovery cannot be restored using Xpress Recovery2.
- USB hard drives are not supported.
- Hard drives in RAID/AHCI mode are not supported.

**** Xpress Recovery2 checks the first physical hard drive in the following sequence: The first PATA IDE connector, the second PATA IDE connector, the first SATA connector, the second SATA connector and so forth. For example, when hard drives are attached to the first IDE and the first SATA connectors, the hard drive on the first IDE connector is the first physical drive. When hard drives are attached to the first and second SATA connectors, the hard drive on the first SATA connector is the first physical drive.

Installation and Configuration

(The following procedure uses Windows XP as the example operating system.)

A. Installing Windows XP and Partitioning the Hard Drive

1. Set CD-ROM drive as the first boot device under "Advanced BIOS Features" in the BIOS Setup program. Save the changes and exit.
2. When partitioning your hard drive (Figure 1), make sure to leave unallocated space for Xpress Recovery2 (10 GB or more is recommended; actual size requirements vary, depending on the amount of data) (Figure 2).

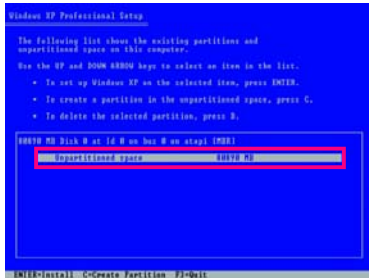

Figure 1

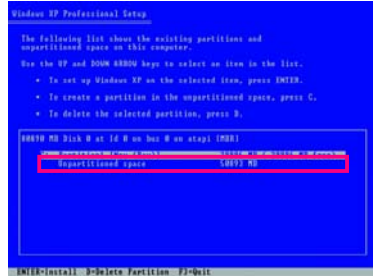

Figure 2

3. Select a file system (for example, NTFS) and begin the installation of the operating system (Figure 3).

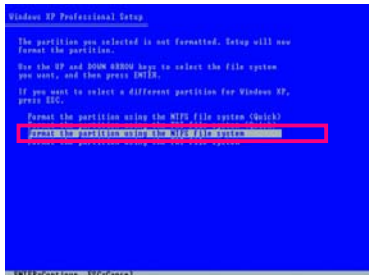

Figure 3

4. After the operating system is installed, right-click the **My Computer** icon on your desktop and select **Manage** (Figure 4). Go to **Computer Management** to check disk allocation. Xpress Recovery2 will save the backup file to the unallocated space (black stripe along the top)(Figure 5). Please note that if there is not enough unallocated space, Xpress Recovery2 cannot save the backup file.

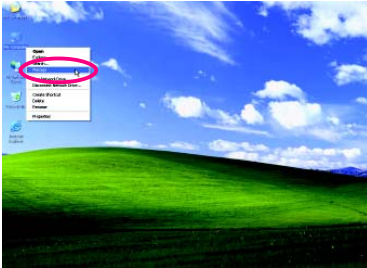

Figure 4

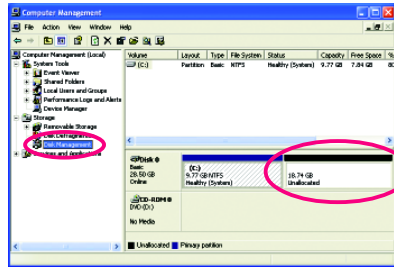

Figure 5

5. If your hard drive is not properly partitioned before you install the operating system, you may create new partitions using free space on your hard drive (Figure 6, 7). However, if **Disk Management** shows the hard drive only contains the System partition without any unallocated space, you will not be able to create new partitions or use Xpress Recovery2. If this occurs, reinstall the operating system and re-partition your hard drive.

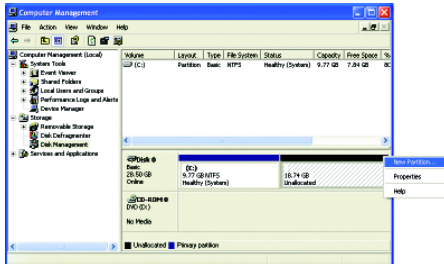

Figure 6

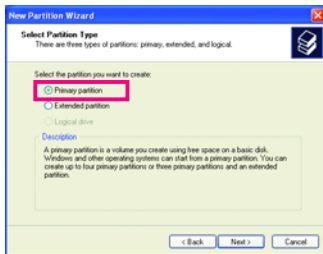

Figure 7

In the New Partition Wizard, you **MUST** select **Primary partition**. This will reserve unallocated space for Xpress Recovery2 to use.

B. Accessing Xpress Recovery2

1. Boot from the motherboard driver disk to access Xpress Recovery2 for the first time. When you see the following message: Press any key to startup Xpress Recovery2 (Figure 8), press any key to enter Xpress Recovery2.

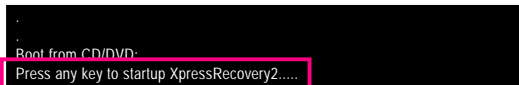

Figure 8

2. After you use the backup function in Xpress Recovery2 for the first time, Xpress Recovery2 will stay permanent in your hard drive. If you wish to enter Xpress Recovery2 later, simply press <F9> during the POST (Figure 9).

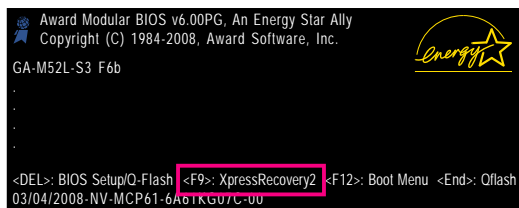

Figure 9

C. Using the Backup Function in Xpress Recovery2

1. Select **BACKUP** to start backing up your hard drive data (Figure 10).
2. Xpress Recovery2 will then begin to search the first physical hard drive as the target drive and detect whether this hard drive contains the Windows operating system. When the Windows operating system is detected, Xpress Recovery2 will begin the backup process (Figure 11).



Figure 10



Figure 11

3. When finished, go to **Disk Management** to check disk allocation.

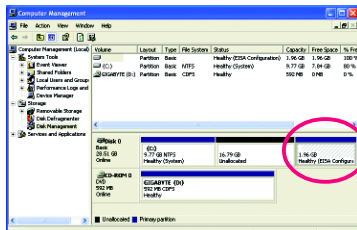

Figure 12

Xpress Recovery2 will automatically create a new partition to store the backup image file.

D. Using the Restore Function in Xpress Recovery2

Select **RESTORE** to restore the backup to your hard drive in case the system breaks down. The **RESTORE** option will not be present if no backup is created before (Figure 13, 14).



Figure 13



Figure 14

E. Removing the Backup

1. If you wish to remove the backup file, select **REMOVE** (Figure 15).
2. After the backup file is removed, no backup image file will be present in **Disk Management** and hard drive space will be freed up (Figure 16).



Figure 15

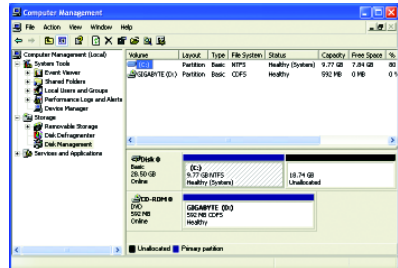

Figure 16

F. Exiting Xpress Recovery2

Select **REBOOT** to exit Xpress Recovery2.



Figure 17

4-2 BIOS Update Utilities

GIGABYTE motherboards provide two unique BIOS update tools, Q-Flash™ and @BIOS™. GIGABYTE Q-Flash and @BIOS are easy-to-use and allow you to update the BIOS without the need to enter MS-DOS mode.



What is Q-Flash™?

With Q-Flash you can update the system BIOS without having to enter operating systems like MS-DOS or Window first. Embedded in the BIOS, the Q-Flash tool frees you from the hassles of going through complicated BIOS flashing process.



What is @BIOS™?

@BIOS allows you to update the system BIOS while in the Windows environment. @BIOS will download the latest BIOS file from the nearest @BIOS server site and update the BIOS.

4-2-1 Updating the BIOS with the Q-Flash Utility

A. Before You Begin:

1. From GIGABYTE's website, download the latest compressed BIOS update file that matches your motherboard model.
2. Extract the file and save the new BIOS file (e.g. M52LS3.F1) to your floppy disk, USB flash drive, or hard drive. Note: The USB flash drive or hard drive must use FAT32/16/12 file system.
3. Restart the system. During the POST, press the <End> key to enter Q-Flash. Note: You can access Q-Flash by either pressing the <End> key during the POST or pressing the <F8> key in BIOS Setup. However, if the BIOS update file is saved to a hard drive in RAID/AHCI mode or a hard drive attached to an independent IDE/SATA controller, use the <End> key during the POST to access Q-Flash.

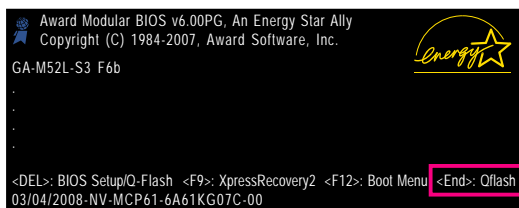

Because BIOS flashing is potentially risky, please do it with caution. Inadequate BIOS flashing may result in system malfunction.

B. Updating the BIOS

When updating the BIOS, choose the location where the BIOS file is saved. The follow procedure assumes that you save the BIOS file to a floppy disk.

Step 1:

1. Insert the floppy disk containing the BIOS file into the floppy disk drive. In the main menu of Q-Flash, use the up or down arrow key to select **Update BIOS from Drive** and press <Enter>.



- The **Save Main BIOS to Drive** option allows you to save the current BIOS file.
- Q-Flash only supports USB flash drive or hard drives using FAT32/16/12 file system.
- If the BIOS update file is saved to a hard drive in RAID/AHCI mode or a hard drive attached to an independent IDE/SATA controller, use the <End> key during the POST to access Q-Flash.

2. Select **Floppy A** and press <Enter>.

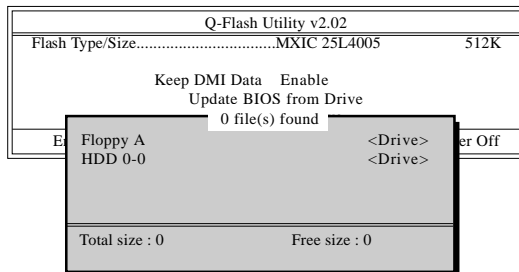

3. Select the BIOS update file and press <Enter>.



Make sure the BIOS update file matches your motherboard model.

Step 2:

The process of the system reading the BIOS file from the floppy disk is displayed on the screen. When the message "Are you sure to update BIOS?" appears, press <Enter> to begin the BIOS update. The monitor will display the update process.



- Do not turn off or restart the system when the system is reading/updating the BIOS.
- Do not remove the floppy disk, USB flash drive, or hard drive when the system is updating the BIOS.

Step 3:

When the update process is complete, press any key to return to the main menu.

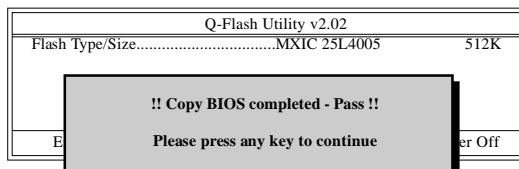

Step 4:

Press <Esc> and then <Enter> to exit Q-Flash and reboot the system. As the system boots, you should see the new BIOS version is present on the POST screen.

Step 5:

During the POST, press <Delete> to enter BIOS Setup. Select **Load Optimized Defaults** and press <Enter> to load BIOS defaults. System will re-detect all peripherals devices after a BIOS update, so we recommend that you reload BIOS defaults.

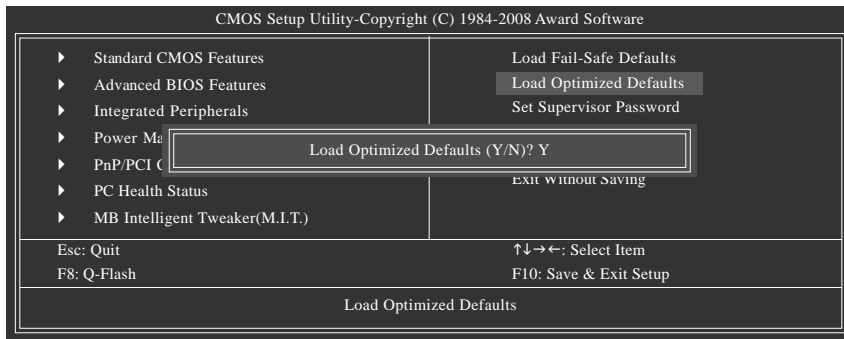

Press <Y> to load BIOS defaults

Step 6:

Select **Save & Exit Setup** and then press <Y> to save settings to CMOS and exit BIOS Setup. The procedure is complete after the system restarts.

4-2-2 Updating the BIOS with the @BIOS Utility

A. Before You Begin:

1. In Windows, close all applications and TSR (Terminate and Stay Resident) programs. This helps prevent unexpected failures when performing a BIOS update.
2. During the BIOS update process, ensure the Internet connection is stable and do NOT interrupt the Internet connection (for example, avoid a power loss or switching off the Internet). Failure to do so may result in a corrupted BIOS or a system that is unable to start.
3. Do not use the C.O.M. (Corporate Online Management) function when using @BIOS.
4. GIGABYTE product warranty does not cover any BIOS damage or system failure resulting from an inadequate BIOS flashing.

B. Installing and Using @BIOS:

Use the motherboard driver disk included with the motherboard to install @BIOS.

- Installing the @BIOS utility.

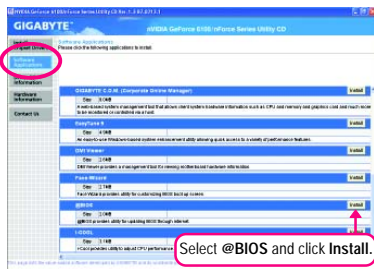

- Accessing the @BIOS utility.

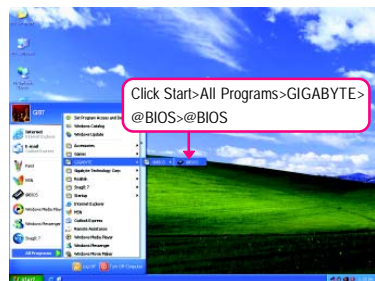

C. Options and Instructions:

1. Save the Current BIOS File
In the main dialog box of @BIOS, **Save Current BIOS** allows you to save the current BIOS file.
2. Update the BIOS Using the Internet Update Function

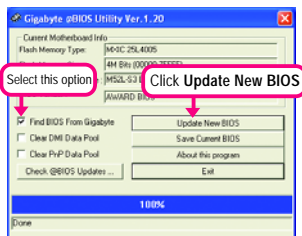

Step 1:

Select the **Find BIOS From Gigabyte** check box and click **Update New BIOS**.

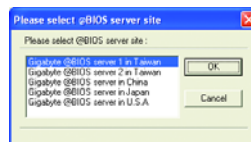

Step 2:

Select the @BIOS server site closest to your location and click **OK**.



Step 3:

First make sure the model name on the screen is correct, then click **OK**. Upon completion, restart your system.



NOTE

- If more than one model is present when doing Step 3 above, reconfirm your motherboard model. Updating the BIOS with an incorrect BIOS file could result in an unbootable system.
- If the BIOS update file for your motherboard is not present on the @BIOS server site, please manually download the BIOS update file from GIGABYTE's website and follow the instructions in "Update the BIOS without Using the Internet Update Function" below.

Step 4:

As the system reboots, press <Delete> to enter the BIOS Setup program. Select **Load Optimized Defaults** and press <Enter> to load BIOS defaults.

3. Update the BIOS without Using the Internet Update Function

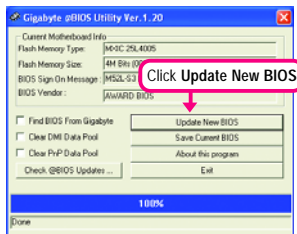

Step 1:

Click **Update New BIOS**.

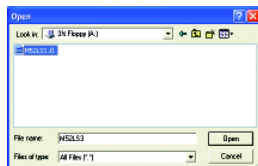

Step 2:

In the **Open** dialog box, select **All Files (*.*)** in the **Files of type** list. Select the location where you save the BIOS update file (e.g. M52LS3.F1) obtained from the Internet or through other source.

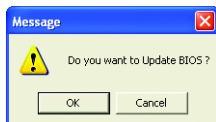

Step 3:

Press **OK** to begin the BIOS update process. Upon completion, restart your system.



NOTE

Make sure the extracted BIOS file matches your motherboard model. Updating the BIOS with an incorrect BIOS file could result in an unbootable system.

Step 4:

As the system boots, press <Delete> to enter the BIOS Setup program. Select **Load Optimized Defaults** and press <Enter> to load BIOS defaults.

4-3 EasyTune 5

EasyTune™ 5, an easy-to-use and convenient system overclocking and management tool, lets you do overclock and overvoltage in Windows environment, eliminating the need to enter the BIOS Setup program. EasyTune 5 provides the following functions (Note 1): overclocking/overvoltage, C.I.A./M.I.B. (Note 2), smart fan control, and hardware monitoring and warning. (For instructions on using EasyTune5, read or download the information on/from the Support\Motherboard\Utility page on our website.)

The EasyTune 5 Interface



Button Information Table

	Button/Display	Description
1.	OVERCLOCKING	Enters the Overclocking setting page
2.	C.I.A./M.I.B.	Enters the C.I.A. and M.I.B. setting page
3.	SMART FAN	Enters the Smart-Fan setting page
4.	PC HEALTH	Enters the PC Health setting page
5.	GO	Confirmation and Execution button
6.	EASY MODE/ADVANCED MODE	Toggles between Easy and Advance Mode
7.	Display Field	Displays panel of CPU frequency
8.	Function LEDs	Shows the information of the current function
9.	GIGABYTE Logo	Visits GIGABYTE website
10.	Help	Displays EasyTune™ 5 help screen
11.	Exit or Minimize	Quits or minimizes EasyTune™ 5



Incorrectly doing overclock/overvoltage may result in damage to CPU, chipset, or memory and reduce the useful life of these components. Before you do the overclock/overvoltage, make sure that you fully know how to use each function of EasyTune 5, or system instability or other unexpected results may occur.

(Note 1) Available functions in EasyTune 5 may differ by motherboard model.

(Note 2) C.I.A. and M.I.B. may provide optimizations for CPU and memory, enhancing the performance of these components.

4-4 Windows Vista ReadyBoost

Windows ReadyBoost allows you to use flash memory on a Windows Vista certified USB flash drive to boost your computer's performance. You may enable ReadyBoost and allocate part of your USB flash drive's memory to speed up your computer.

Follow the steps below to enable the ReadyBoost function:

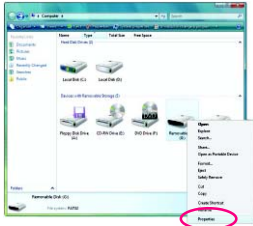

Step 1:

Go to **Computer**. Right-click on the USB flash drive icon and choose **Properties**.

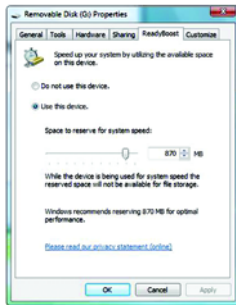

Step 2:

In the **ReadyBoost** tab, select **Use this device**. Under **Space to reserve for system speed**, set the amount of memory space to use for ReadyBoost using the slider or spin box. Click **Apply** and then **OK** to turn on ReadyBoost.



- The USB flash drive must have at least 256 MB of space.
- The recommended amount of memory to use for ReadyBoost acceleration is one to three times the amount of RAM installed in your computer.

Chapter 5 Appendix

5-1 Configuring SATA Hard Drive(s)

To configure SATA hard drive(s), follow the steps below:

- A. Install SATA hard drive(s) in your computer.
- B. Configure SATA controller mode in BIOS Setup.
- C. Configure a RAID array in RAID BIOS. ^(Note)
- D. Make a floppy disk containing the SATA RAID driver. ^(Note)
- E. Install the SATA RAID driver ^(Note) and operating system.

Before you begin

Please prepare:

- At least two SATA hard drives (to ensure optimal performance, it is recommended that you use two hard drives with identical model and capacity). If you do not want to create RAID, you may prepare only one hard drive.
- An empty formatted floppy disk.
- Windows Vista/XP/2000 setup disk.
- Motherboard driver disk.

5-1-1 Configuring the Onboard SATA Controller

A. Installing SATA hard drive(s) in your computer

Attach one end of the SATA signal cable to the rear of the SATA hard drive and the other end to an available SATA port on the motherboard. Then connect the power connector from your power supply to the hard drive.

(Note) Skip this step if you do not want to create RAID array on the SATA controller.

B. Configuring SATA controller mode in BIOS Setup

Make sure to configure the SATA controller mode correctly in system BIOS Setup.

Step 1:

Turn on your computer and press <Delete> to enter BIOS Setup during the POST (Power-On Self-Test). Under **Integrated Peripherals**, ensure **NV SATA Controller** is enabled. To configure a RAID array, go to the **Serial-ATA RAID Config** submenu.

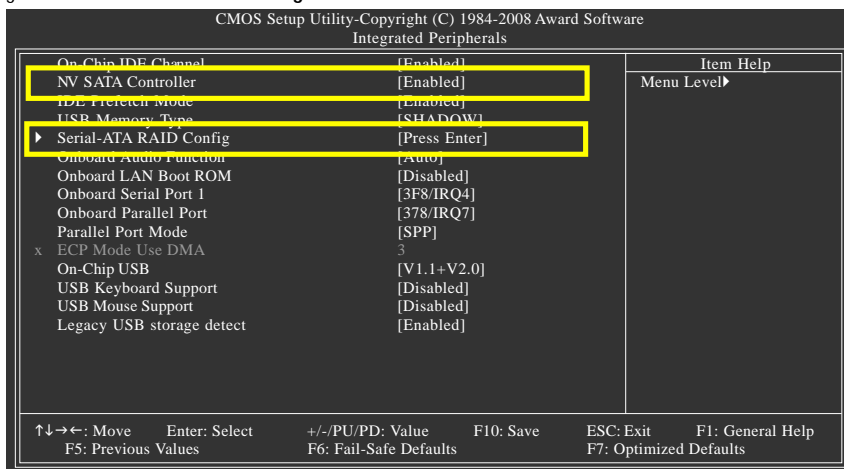

Figure 1

Set **NV SATA RAID function** to **Enabled** to enable RAID control for the first and second SATA connector. Make sure **NV SATA 1 Primary RAID** and **NV SATA 1 Secondary RAID** are enabled. (Figure 2)

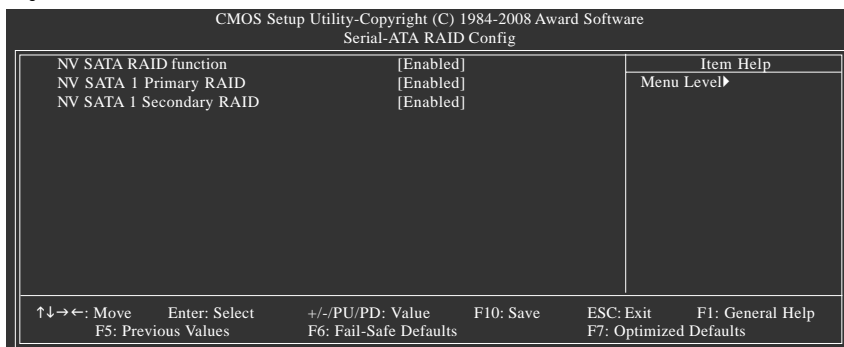

Figure 2

Step 2:

Save changes and exit BIOS Setup.



NOTE The BIOS Setup menus described in this section may differ from the exact settings for your motherboard. The actual BIOS Setup menu options you will see shall depend on the motherboard you have and the BIOS version.

C. Configuring RAID set in RAID BIOS

Enter the RAID BIOS setup utility to configure a RAID array. For a non-RAID configuration, please skip this step and proceed to the installation of Windows operating system.

Step 1:

After the POST memory test begins and before the operating system boot begins, look for a message which says "Press <F10> to enter RAID setup utility" (Figure 3). Hit the <F10> key to enter the NVIDIA RAID setup utility.

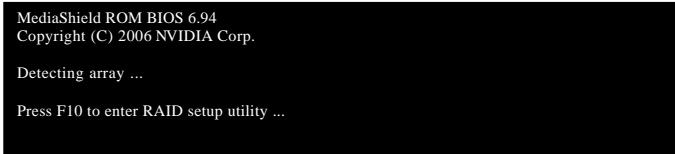

Figure 3

Step 2:

The **Define a New Array** screen is the first option screen when you enter the NVIDIA RAID setup utility. (Figure 4). You can press the <Tab> key to move from field to field until the appropriate field is highlighted.

Step 3:

In the **RAID Mode** field, use the up or down arrow key to select a RAID mode. The supported RAID modes include Mirroring, Striping, and Spanning. The following procedure demonstrates how a RAID 0 array (Striping) is created.

Step 4:

If RAID 0 (Striping) is selected, you can manually set the stripe block size. In the **Striping Block** field, use the up or down arrow key to set the striping block size. Striping block size is given in kilobytes. We recommend you leaving it at the default **Optimal**, which is 64KB. The striping block size can be set from 4 KB to 128 KB

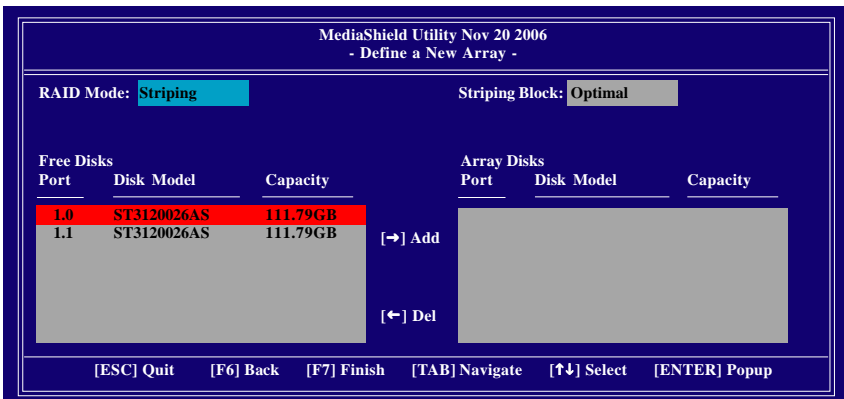

Figure 4

Step 5:

Next, select the hard drives which you wish to be included in the disk array. The **Free Disks** block displays the information about the SATA hard drives that are available for use as RAID array drives. Press <Tab> to move to the **Free Disks** block. Select the target hard drives using the up or down arrow key and use the right arrow key to add the hard drives to the **Array Disks** block (Figure 5).

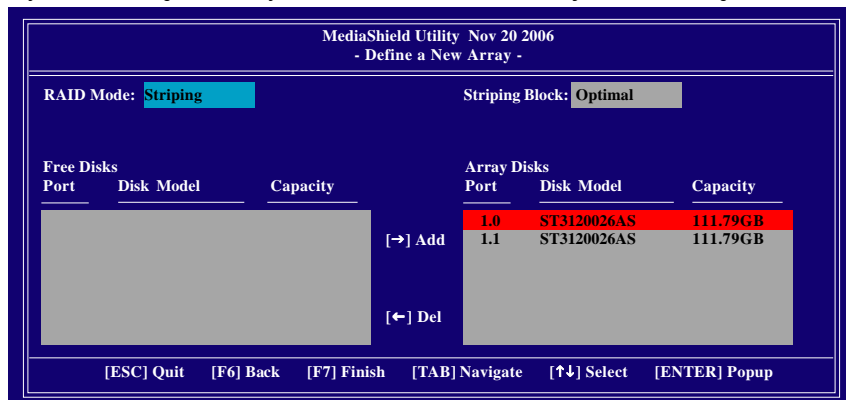

Figure 5

Step 6:

After assigning the RAID drives, press <F7>. A message which says "Clear disk data?" appears (Figure 6). Press <Y> to confirm or press <N> to cancel. (If the hard drives contain a previously created RAID array, you need to press <Y> to clear the data in the hard drives.)

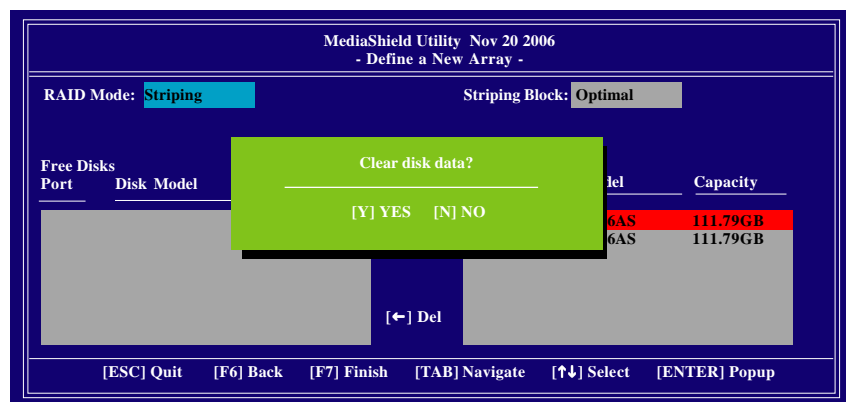

Figure 6

After that, the **Array List** screen appears, displaying the RAID array that you have created (Figure 7).

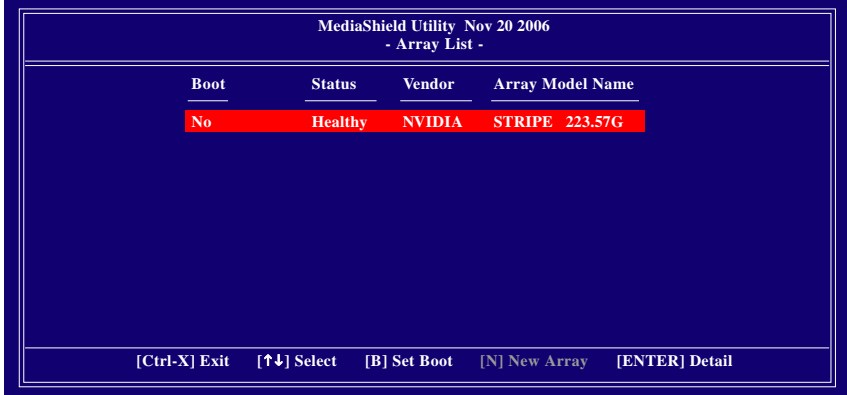

Figure 7

To read more information about the RAID array, press <Enter> to enter the **Array Detail** screen (Figure 8), which shows various information about the array, including the RAID mode, stripe block size, hard drive model name, and hard drive capacity, etc.

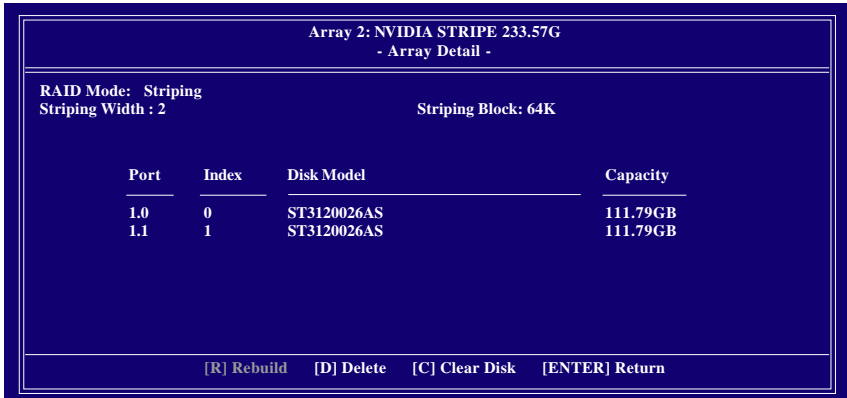

Figure 8

To delete the array, press <D> in the **Array Detail** screen. When the "Delete this array?" message appears, press <Y> to confirm or <N> to cancel. Press <Enter> to return to the **Array List** screen.

To exit the NVIDIA RAID setup utility, press <Esc> in the main menu or <Ctrl>+<X> in the **Array List** screen.

Now, you can proceed to the installation of the SATA controller driver and operating system.

5-1-2 Making a SATA RAID Driver Diskette (For Windows XP and 2000)

To successfully install Windows XP/2000 onto SATA hard drive(s) that is/are configured to RAID mode, you need to install the SATA controller driver during the OS installation. Without the driver, the hard drive may not be recognized during the Windows setup process. First of all, copy the driver for the SATA controller from the motherboard driver disk to a floppy disk. See the instructions below about how to copy the driver in MS-DOS mode^(Note). Prepare a startup disk that has CD-ROM support and a blank formatted floppy disk.

Step 1: Insert the prepared startup disk and the motherboard driver disk for Windows XP in your system. Boot from the startup disk. Once at the A:\> prompt, change to your optical drive (example: D:\>). At the D:\> prompt, type the following two commands. Press <Enter> after each command (Figure 1):

```
cd bootdrv
menu
```

Step 2: When the controller menu (Figure 2) appears, remove the startup disk and insert the blank formatted disk. Select the controller driver by pressing the corresponding letter from the menu. In the example in Figure 2, the **NVIDIA MCP61 DRIVER** series are for the NVIDIA® nForce 520LE(Geforce 6100/nForce 430) chipset. For example, to install Windows XP (32-bit) onto the RAID drives, press <A> to select **A)nVIDIA MCP61 Series Raid(XP)**. The **B)nVIDIA MCP61 Series Raid(64Bit)** is for Windows XP 64-bit and **9)nVIDIA MCP61 Series Raid(2K)** for Windows 2000. Your system will then automatically zip and transfer this driver file to the floppy disk. Press <0> to exit when finished.

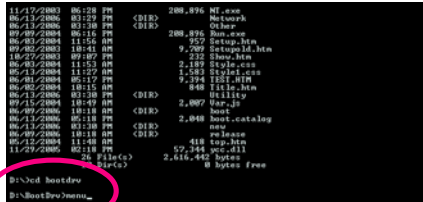

Figure 1

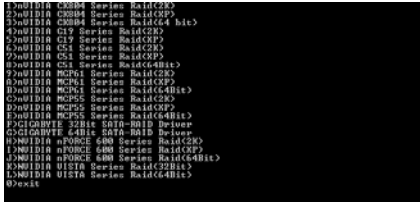

Figure 2

(Note) For users without a startup disk: Use an alternative system and insert the motherboard driver disk. From your optical drive folder, double click the **MENU.exe** file in the **BootDrv** folder (Figure 3). A command prompt window will open similar to that in Figure 2.

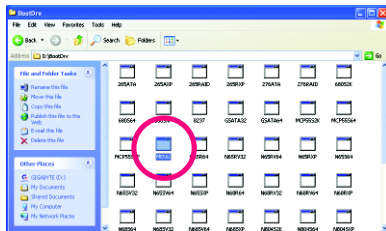

Figure 3

5-1-3 Installing the SATA RAID Driver and Operating System

Now that you have prepared the SATA RAID driver diskette for Windows XP/2000 and configured the required BIOS settings, you are ready to install the operating system onto your hard drive(s). Please note that installation of Windows Vista does not require you to install the RAID driver during the OS installation process. The following is an example of Windows XP installation.

Step 1: Restart your system to boot from the Windows XP setup disk and press <F6> as soon as you see the message "Press F6 if you need to install a 3rd party SCSI or RAID driver" (Figure 1). After pressing <F6>, there will be a few moments of some files being loaded before you see the next screen.



Figure 1

Step 2:

When a screen similar to that below appears, insert the floppy disk containing the SATA RAID driver and press <S> (Figure 2).

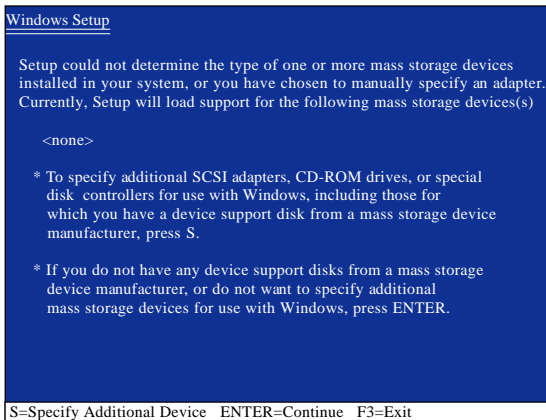

Figure 2

Step 3:

When installing the RAID driver, for example, if Setup correctly recognizes the driver in the floppy disk, a controller menu similar to that in Figure 3 below will appear. Use the arrow keys to select **NVIDIA RAID CLASS Driver** and press <Enter>. Later, when a screen similar to that in Figure 4 appears, you must press <S> to select an additional driver. The screen will return to previous screen as shown in Figure 3. Select **NVIDIA nForce Storage Controller** and press <Enter>.

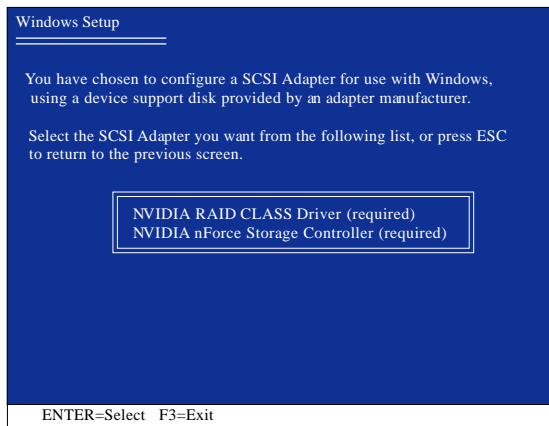

Figure 3

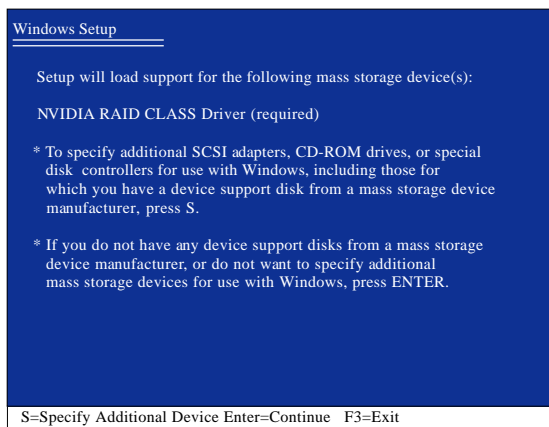

Figure 4



If a message appears saying one or some file(s) cannot be found, please check the floppy disk or copy the correct SATA RAID driver again from the motherboard driver disk.

When the screen as shown below appears, press <Enter> to continue the driver installation from the floppy disk. The driver installation will be finished in about one minute.

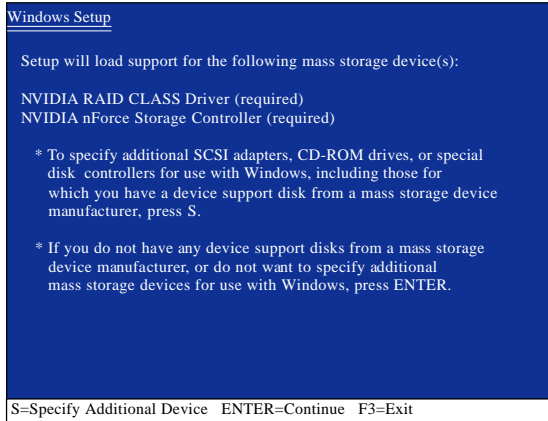

Figure 5

Step 4:

After the SATA controller driver installation is completed, you can proceed with the Windows XP installation.

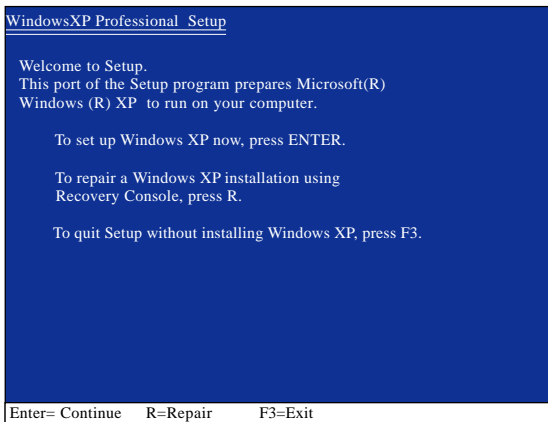

Figure 6

5-2 Configuring Audio Input and Output

5-2-1 Configuring 2/4/5.1/7.1-Channel Audio

The motherboard provides six audio jacks on the back panel which support 2/4/5.1/7.1-channel audio. The picture to the right shows the default audio jack assignments.

The integrated HD (High Definition) audio provides jack retasking capability that allows the user to change the function for each jack through the audio driver.

For example, in a 4-channel audio configuration, if a Rear speaker is plugged into the default Center/Subwoofer speaker out jack, you can retask the Center/Subwoofer speaker out jack to be Rear speaker out.



- To install a microphone, connect your microphone to the Mic in jack and manually configure the jack for microphone functionality.
- If your front panel audio supports Intel HD Audio standard, you can have both the front and back panel audio connectors active simultaneously.

High Definition Audio (HD Audio)

HD Audio includes multiple high quality digital-to-analog converters (DACs) that support 44.1KHz/48KHz/96KHz/192KHz sampling rate. HD Audio features multistreaming capabilities that allow multiple audio streams (in and out) to be simultaneously processed. For example, users can listen to MP3 music, have an Internet chat, make a telephone call over the Internet, and etc. all at the same time.

A. Configuring Speakers:

(The following instructions use Windows XP as the example operating system.)

Step 1:

After installing the audio driver, the **Audio Manager** icon  will appear in your system tray. Double-click the icon to access the Audio Control Panel.



CAUTION

Before installing the audio driver, make sure the "Microsoft UAA Bus driver for High Definition Audio" has been installed from the motherboard driver disk and your operating system has been updated with the latest Service Pack for Windows.

(Note) 2/4/5.1/7.1 -Channel Audio Configurations:

Refer to the following for multi-channel speaker configurations.

- 2-channel audio: Headphone or Line out.
- 4-channel audio: Front speaker out and Rear speaker out.
- 5.1-channel audio: Front speaker out, Rear speaker out, and Center/Subwoofer speaker out.
- 7.1-channel audio: Front speaker out, Rear speaker out, Center/Subwoofer speaker out, and Side speaker out.

Step 2:

Click the **Audio I/O** tab. In the speaker list on the left, select **2CH Speaker**, **4CH Speaker**, **6CH Speaker**, or **8CH Speaker** according to the type of speaker configuration you wish to set up.

**Step 3:**

Everytime you connect an audio device to an audio jack, the **Connected device** box appears. Select the device according to the type of device you connect. Then click **OK** to complete the configuration.

**B. Configuring Sound Effect:**

You may configure an audio environment on the **Sound Effect** tab.

**C. Configuring AC'97 Audio:**

If you want to connect an AC'97 front panel audio module, click the tool icon on the **Audio I/O** tab. On the **Global Connector Settings** box, select the **Disable front panel jack detection** check box. Click **OK** to activate the AC'97 functionality.



When using an AC'97 front panel audio module, you can only have audio signals present on either the front or the back panel audio connections, but not both at the same time.

5-2-2 Installing the S/PDIF In Cable (Optional)

The S/PDIF in cable provides S/PDIF in functionality.

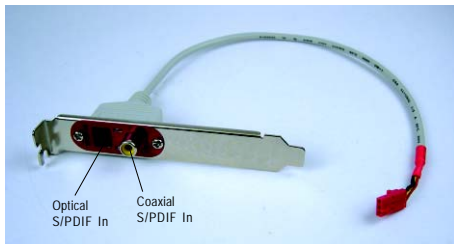

S/PDIF In:

The S/PDIF in jacks allow you to input digital audio signals to the computer for audio processing.

A. Installing the S/PDIF In Cable:

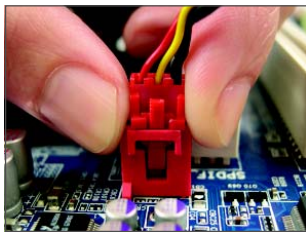

Step 1:

First, attach the connector at the end of the cable to the SPDIF_I header on your motherboard.

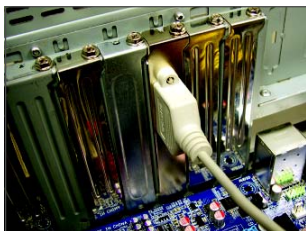

Step 2:

Secure the metal bracket to the chassis back panel with a screw.

S/PDIF Out:

The S/PDIF out jack can transmit audio signals to an external decoder for decoding to get the best audio quality.

B. Connecting a S/PDIF out Cable



S/PDIF Coaxial Cable

Connect a S/PDIF coaxial cable to an external decoder for transmitting the S/PDIF digital audio signals.

C. Configuring S/PDIF out:

Click the tool icon in the **DIGITAL** section. In the **S/PDIF In/Out Settings** dialog box, select an output sampling rate and select (or disable) the output source. Click **OK** to complete the configuration.

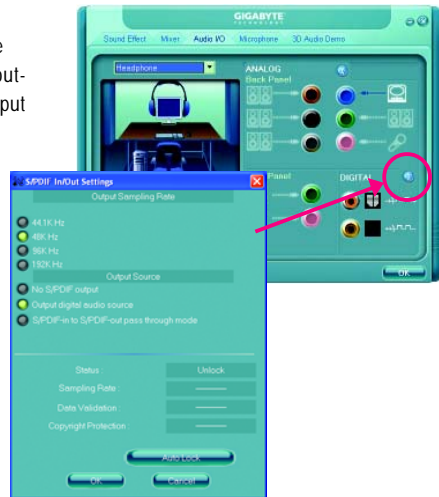

5-2-3 Configuring Microphone Recording

Step 1:

After installing the audio driver, the **Audio Manager** icon  will appear in your system tray. Double-click the icon to access the Audio Control Panel.



Step 2:

Connect your microphone to the Mic in jack (pink) on the back panel or the Mic in jack (pink) on the front panel. Then configure the jack for microphone functionality.

Note: The microphone functions on the front panel and back panel cannot be used at the same time.



Step 3:

Locate the **Volume** icon  in your system tray and click it to open the volume control panel.

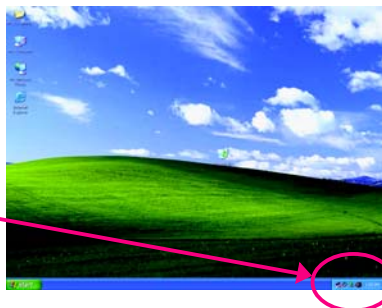

Step 4:

To hear the sound being recorded during the recording process when using the microphone function on the front panel, do not select the **Mute** check box under **Front Pink In** or **Front Green In** in **Master Volume**. It is recommended that you set the volume at a middle level.



To hear the sound being recorded during the recording process when using the microphone function on the back panel, do not select the **Mute** check box under **Rear Pink In** in **Master Volume**. It is recommended that you set the volume at its middle level.

(Note)

If you cannot find the volume control options you need in **Master Volume**, go to the **Options** menu and then choose **Properties**. Select the volume control options you wish to show and click **OK** to complete.

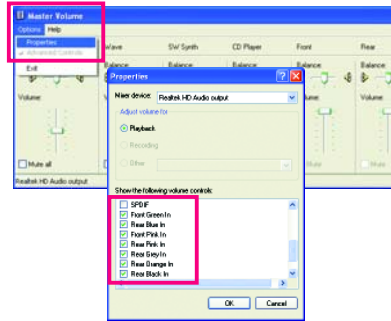

Step 5:

Next, while in **Master Volume**, go to **Options** and click **Properties**. In the **Mixer device** list, select **Realtek HD Audio Input**. Then set the recording sound level properly. Do NOT mute the recording sound, or you will not hear any sound when playing back the recording you just made.

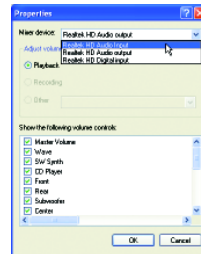

Select Realtek HD Audio Input in the Mixer device list

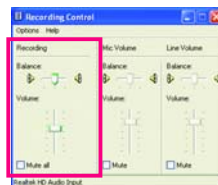

Recording Control

Step 6:

To raise the recording and playing sound for the microphone, go to **Options in Master Volume** and select **Advanced Controls**. Click the **Advanced** button under a volume control option (e.g. Front Green In, Front Pink In). In the **Other Controls** field, select the **1 Microphone Boost** check box.

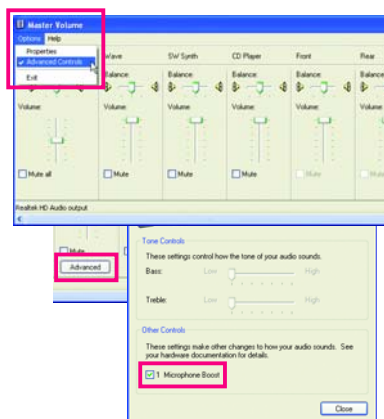



Step 7:

After completion, click **Start**, point to **All Programs**, point to **Accessories**, point to **Entertainment**, and then click **Sound Recorder** to begin the sound recording.







5-2-4 Using the Sound Recorder

Recording the Sound:

1. Make sure you have connected the audio input device (e.g. microphone) to the computer.
2. On the **File** menu, choose **New**.
3. To record a sound file, click the **Recording** button .
4. To stop the recording, click the **Stop** button . Be sure to save the recording upon completion.



Playing the Sound:

1. On the **File** menu, choose **Open**.
2. In the **Open** dialog box, select the sound (.wav) file you wish to play.
3. To play a sound file, click the **Play** button .
4. To stop playing, click the **Stop** button .
5. You may use the **Fast Forward** button  to move to the beginning of a file or the **Fast Backward** button  to the end.

5-3 Troubleshooting

5-3-1 Frequently Asked Questions

To read more FAQs for your motherboard, please go to the Support\Motherboard\FAQ page on GIGABYTE's website.

Q: In the BIOS Setup program, why are some BIOS options missing?

A: Some advanced options are hidden in the BIOS Setup program. Press <Delete> to enter BIOS Setup during the POST. In the Main Menu, press <Ctrl>+<F1> to show the advanced options.

Q: Why is the light of my keyboard/optical mouse still on after the computer shuts down?

A: Some motherboard provides a small amount of standby power after the computer shuts down and that's why the light is still on.

Q: How do I clear the CMOS values?

A: If your motherboard has a clearing CMOS jumper, refer to the instructions on the CLR_CMOS jumper in Chapter 1 to short the jumper to clear the CMOS values. If your board doesn't have this jumper, refer to the instructions on the motherboard battery in Chapter 1. You can temporarily remove the battery from the battery holder to stop supplying power to the CMOS, which will clear the CMOS values after about one minute. Refer to the steps below:

Steps:

1. Turn off your computer and unplug the power cord.
2. Gently remove the battery from the battery holder and wait for one minute.
(Or use a metal object like a screwdriver to touch the positive and negative terminals of the battery holder, making them short for 5 seconds.)
3. Replace the battery.
4. Plug in the power cord and restart your computer.
5. Press <Delete> to enter BIOS Setup. Select "Load Fail-Safe Defaults" (or "Load Optimized Defaults") to load BIOS default settings.
6. Saves changes and exit BIOS Setup (select "Save & Exit Setup") to restart your computer.

Q: Why do I still get a weak sound even though I have turned my speaker to the maximum volume?

A: Make sure your speaker is equipped with an internal amplifier. If not, try a speaker with power/amplifier.

Q: What do the beeps emitted during the POST mean?

A: The following Award BIOS beep code descriptions may help you identify possible computer problems.
(For reference only.)

1 short: System boots successfully

2 short: CMOS setting error

1 long, 1 short: Memory or motherboard error

1 long, 2 short: Monitor or graphics card error

1 long, 3 short: Keyboard error

1 long, 9 short: BIOS ROM error

Continuous long beeps: Graphics card not inserted properly

Continuous short beeps: Power error

5-3-2 Troubleshooting Procedure

If you encounter any troubles during system startup, follow the troubleshooting procedure below to solve the problem.

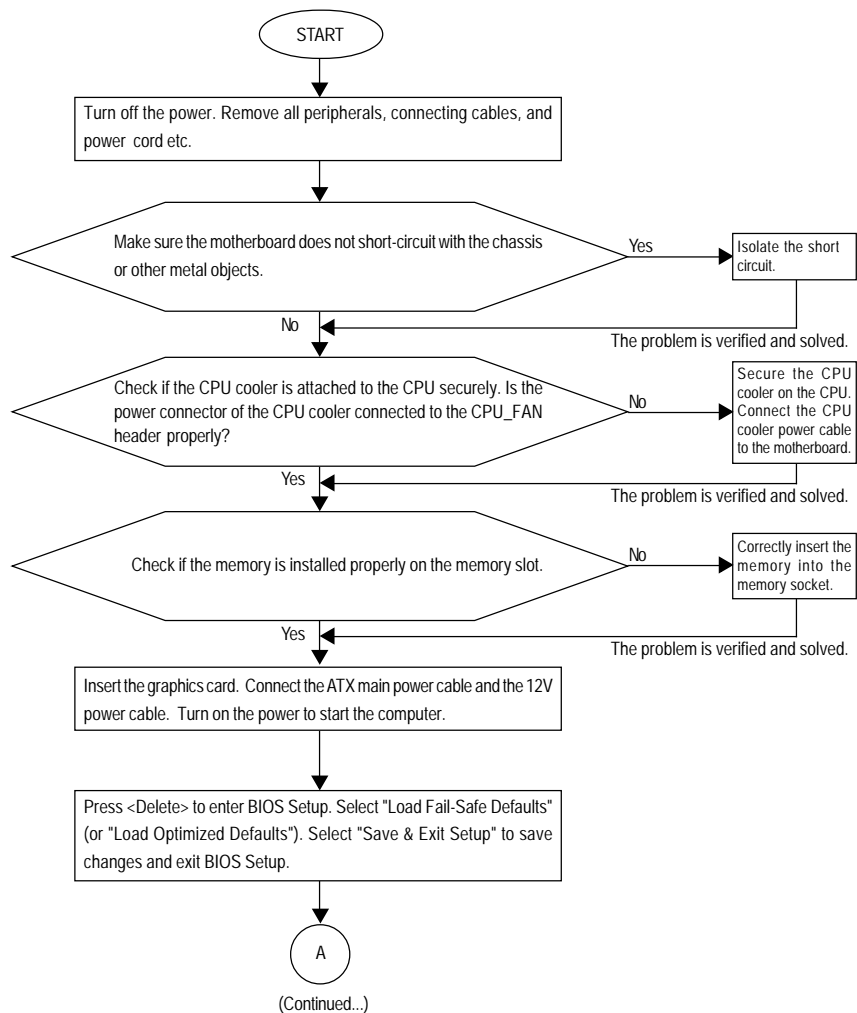

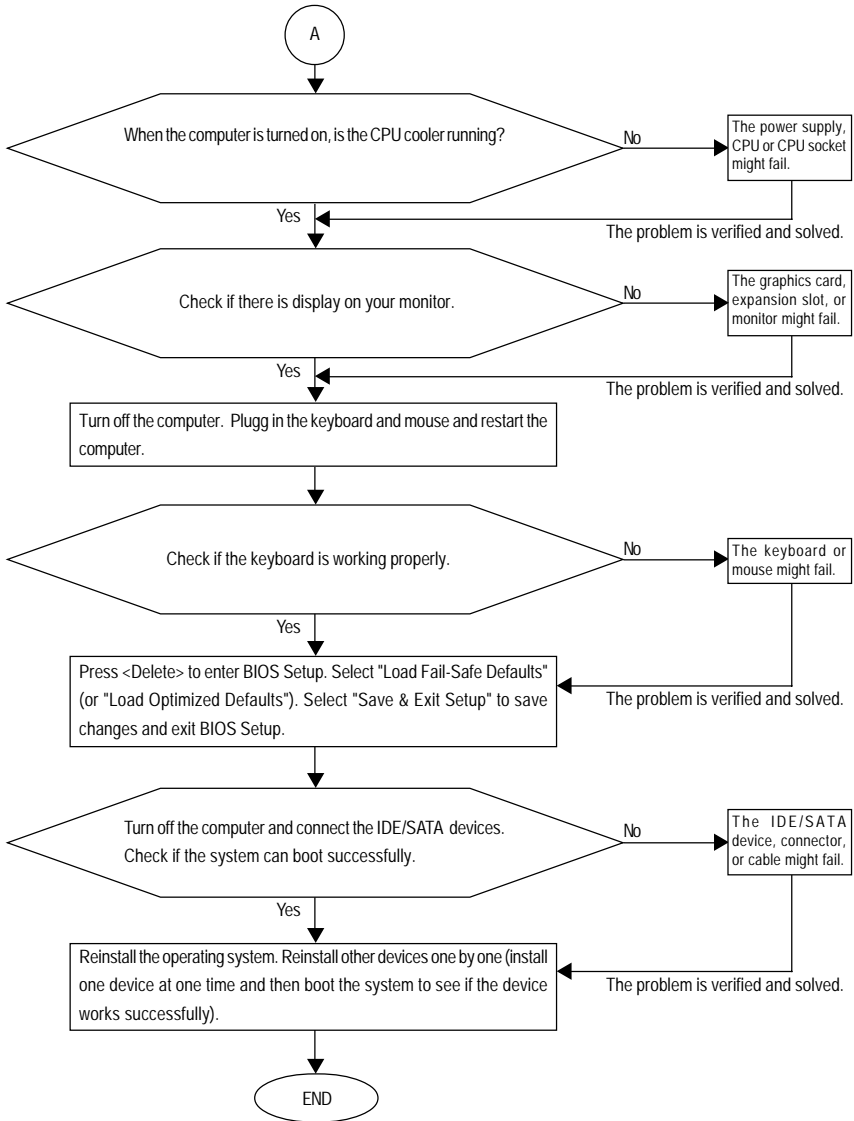

If the procedure above is unable to solve your problem, contact the place of purchase or local dealer for help. Or go to the Support\Technical Service Zone page to submit your question. Our customer service staff will reply you as soon as possible.

Regulatory Statements

Regulatory Notices

This document must not be copied without our written permission, and the contents there of must not be imparted to a third party nor be used for any unauthorized purpose. Contravention will be prosecuted. We believe that the information contained herein was accurate in all respects at the time of printing. GIGABYTE cannot, however, assume any responsibility for errors or omissions in this text. Also note that the information in this document is subject to change without notice and should not be construed as a commitment by GIGABYTE.

Our Commitment to Preserving the Environment

In addition to high-efficiency performance, all GIGABYTE motherboards fulfill European Union regulations for RoHS (Restriction of Certain Hazardous Substances in Electrical and Electronic Equipment) and WEEE (Waste Electrical and Electronic Equipment) environmental directives, as well as most major worldwide safety requirements. To prevent releases of harmful substances into the environment and to maximize the use of our natural resources, GIGABYTE provides the following information on how you can responsibly recycle or reuse most of the materials in your "end of life" product.

Restriction of Hazardous Substances (RoHS) Directive Statement

GIGABYTE products have not intended to add and safe from hazardous substances (Cd, Pb, Hg, Cr+6, PBDE and PBB). The parts and components have been carefully selected to meet RoHS requirement. Moreover, we at GIGABYTE are continuing our efforts to develop products that do not use internationally banned toxic chemicals.

Waste Electrical & Electronic Equipment (WEEE) Directive Statement

GIGABYTE will fulfill the national laws as interpreted from the 2002/96/EC WEEE (Waste Electrical and Electronic Equipment) directive. The WEEE Directive specifies the treatment, collection, recycling and disposal of electric and electronic devices and their components. Under the Directive, used equipment must be marked, collected separately, and disposed of properly.

WEEE Symbol Statement



The symbol shown below is on the product or on its packaging, which indicates that this product must not be disposed of with other waste. Instead, the device should be taken to the waste collection centers for activation of the treatment, collection, recycling and disposal procedure. The separate collection and recycling of your waste equipment at the time of disposal will help to conserve natural resources and ensure that it is recycled in a manner that protects human health and the environment. For more information about where you can drop off your waste equipment for recycling, please contact your local government office, your household waste disposal service or where you purchased the product for details of environmentally safe recycling.

- When your electrical or electronic equipment is no longer useful to you, "take it back" to your local or regional waste collection administration for recycling.
- If you need further assistance in recycling, reusing in your "end of life" product, you may contact us at the Customer Care number listed in your product's user's manual and we will be glad to help you with your effort.

Finally, we suggest that you practice other environmentally friendly actions by understanding and using the energy-saving features of this product (where applicable), recycling the inner and outer packaging (including shipping containers) this product was delivered in, and by disposing of or recycling used batteries properly. With your help, we can reduce the amount of natural resources needed to produce electrical and electronic equipment, minimize the use of landfills for the disposal of "end of life" products, and generally improve our quality of life by ensuring that potentially hazardous substances are not released into the environment and are disposed of properly.

China Restriction of Hazardous Substances Table

The following table is supplied in compliance with China's Restriction of Hazardous Substances (China RoHS) requirements:



关于符合中国《电子信息产品污染控制管理办法》的声明
Management Methods on Control of Pollution from Electronic Information Products
(China RoHS Declaration)

产品中有毒有害物质或元素名称及含量
Hazardous Substances Table

部件名称 (Parts)	有毒有害物质或元素 (Hazardous Substances)					
	铅 (Pb)	汞 (Hg)	镉 (Cd)	六价铬 (Cr (VI))	多溴联苯 (PBB)	多溴二苯醚 (PBDE)
PCB板 PCB	○	○	○	○	○	○
结构件及风扇 Mechanical parts and Fan	×	○	○	○	○	○
芯片及其他主动零件 Chip and other Active components	×	○	○	○	○	○
连接器 Connectors	×	○	○	○	○	○
被动电子元器件 Passive Components	×	○	○	○	○	○
线材 Cables	○	○	○	○	○	○
焊接金属 Soldering metal	○	○	○	○	○	○
助焊剂, 散热膏, 标签及其他耗材 Flux, Solder Paste, Label and other Consumable Materials	○	○	○	○	○	○
○: 表示该有毒有害物质在该部件所有均质材料中的含量均在SJ/T11363-2006标准规定的限量要求以下。 Indicates that this hazardous substance contained in all homogenous materials of this part is below the limit requirement SJ/T 11363-2006						
×: 表示该有毒有害物质至少在该部件的某一均质材料中的含量超出SJ/T11363-2006标准规定的限量要求。 Indicates that this hazardous substance contained in at least one of the homogenous materials of this part is above the limit requirement in SJ/T 11363-2006						
对销售之日的所发售产品, 本表显示我公司供应链的电子信息产品可能包含这些物质。注意: 在所售产品中可能会也可能不会含有所有列出的部件。 This table shows where these substances may be found in the supply chain of our electronic information products, as of the date of the sale of the enclosed products. Note that some of the component types listed above may or may not be a part of the enclosed product.						



Contact Us

● Taiwan (Headquarters)

GIGA-BYTE TECHNOLOGY CO., LTD.

Address: No.6, Bau Chiang Road, Hsin-Tien,

Taipei 231, Taiwan

TEL: +886-2-8912-4888

FAX: +886-2-8912-4003

Tech. and Non-Tech. Support (Sales/Marketing) :

<http://gigs.gigabyte.com.tw>

WEB address (English): <http://www.gigabyte.com.tw>

WEB address (Chinese): <http://www.gigabyte.tw>

● U.S.A.

G.B.T. INC.

TEL: +1-626-854-9338

FAX: +1-626-854-9339

Tech. Support:

<http://rma.gigabyte-usa.com>

Web address: <http://www.gigabyte.us>

● Mexico

G.B.T Inc (USA)

Tel: +1-626-854-9338 x 215 (Soporte de habla hispano)

FAX: +1-626-854-9339

Correo: soporte@gigabyte-usa.com

Tech. Support:

<http://rma.gigabyte-usa.com>

Web address: <http://www.gigabyte.com.mx>

● Singapore

GIGA-BYTE SINGAPORE PTE. LTD.

WEB address : <http://www.gigabyte.sg>

● Thailand

WEB address : <http://th.giga-byte.com>

● Vietnam

WEB address : <http://www.gigabyte.vn>

● China

NINGBO G.B.T. TECH. TRADING CO., LTD.

WEB address : <http://www.gigabyte.cn>

Shanghai

TEL: +86-21-63410999

FAX: +86-21-63410100

Beijing

TEL: +86-10-62102838

FAX: +86-10-62102848

Wuhan

TEL: +86-27-87851061

FAX: +86-27-87851330

GuangZhou

TEL: +86-20-87540700

FAX: +86-20-87544306 ext. 333

Chengdu

TEL: +86-28-85236930

FAX: +86-28-85256822 ext. 814

Xian

TEL: +86-29-85531943

FAX: +86-29-85539821

Shenyang

TEL: +86-24-83992901

FAX: +86-24-83992909

● India

GIGABYTE TECHNOLOGY (INDIA) LIMITED

WEB address : <http://www.gigabyte.in>

● Saudi Arabia

WEB address : <http://www.gigabyte.com.sa>

● Australia

GIGABYTE TECHNOLOGY PTY. LTD.

WEB address : <http://www.gigabyte.com.au>

- **Germany**

G.B.T. TECHNOLOGY TRADING GMBH

WEB address : <http://www.gigabyte.de>

- **U.K.**

G.B.T. TECH. CO., LTD.

WEB address : <http://www.giga-byte.co.uk>

- **The Netherlands**

GIGA-BYTE TECHNOLOGY B.V.

WEB address : <http://www.giga-byte.nl>

- **Sweden**

WEB address : <http://www.gigabyte.se>

- **France**

GIGABYTE TECHNOLOGY FRANCE

WEB address : <http://www.gigabyte.fr>

- **Italy**

WEB address : <http://www.giga-byte.it>

- **Spain**

GIGA-BYTE SPAIN

WEB address : <http://www.giga-byte.es>

- **Czech Republic**

Representative Office Of GIGA-BYTE Technology Co., Ltd.
in CZECH REPUBLIC

WEB address : <http://www.gigabyte.cz>

- **Turkey**

Representative Office Of GIGA-BYTE Technology Co., Ltd.
in TURKEY

WEB address : <http://www.gigabyte.com.tr>

- **Russia**

Moscow Representative Office Of GIGA-BYTE Technology Co., Ltd.

WEB address : <http://www.gigabyte.ru>

- **Latvia**

GIGA-BYTE Latvia

WEB address : <http://www.gigabyte.lv>

- **Poland**

Office of GIGA-BYTE TECHNOLOGY Co., Ltd. in POLAND

WEB address : <http://www.gigabyte.pl>

- **Ukraine**

WEB address : <http://www.giga-byte.com.ua>

- **Romania**

Representative Office Of GIGA-BYTE Technology Co., Ltd.
in Romania

WEB address : <http://www.gigabyte.com.ro>

- **Serbia & Montenegro**

Representative Office Of GIGA-BYTE Technology Co., Ltd.
in SERBIA & MONTENEGRO

WEB address : <http://www.gigabyte.co.yu>

You may go to the GIGABYTE website, select your language
in the language list on the top right corner of the website.

- **GIGABYTE Global Service System**



To submit a technical or non-technical (Sales/ Marketing) question, please link to :

<http://ggts.gigabyte.com.tw>

Then select your language to enter the system.